

# H2O PITLESS CONTROL UNITS

Galvanized Steel or PVC



LEARN MORE ABOUT THE BEST IN THE INDUSTRY AT [merrillmfg.com](http://merrillmfg.com)

# H2O PITLESS CONTROL

## FEATURES AND BENEFITS

- A Connects to 4", 5", 6", or 8" steel or PVC well casing**  
**Benefit** - Easy attachment to the casing - sizes you need.
- B Constant pressure controls can be mounted at the well**  
**Benefit** - One universal plate holds VFD drive or all USA Pump Co., and VFD drive is now protected inside top of the well, out of the weather.
- C 12" Pipe in galvanized steel or PVC at top of well contains everything**  
**Benefit** - All needed connections for controls are designed to fit inside a 12" casing - compact installation.
- D Expansion tank included inside H2O pitless control units**  
**Benefit** - Small tank recommended for VFD drive installations is included with the H2O pitless control unit.
- E Internal manifold of unit has pull strap for easy removal to service well**  
**Benefit** - No special pulling tool needed for service work - pulling strap built in.
- F Internal manifold of unit has tappings for expansion tank, pressure transducer, pressure relief valve, and pressure gauge**  
**Benefit** - Minimum work required to complete the installation - all needed tappings included.
- G No lead brass waterways, pitless adapter, and internal manifold**  
**Benefit** - In compliance with safe water drinking act for residential drinking water supply.
- H Universal aluminum VFD mounting plate attached to top lid of watertight cap**  
**Benefit** - VFD drive easily mounted for at the well control and out of the weather.
- I Approved by Wisconsin DNR and Minnesota Department of Health several other states (code approved)**  
**Benefit** - Most all states that require a product to be code approved have approved the H2O pitless control unit.

Since 2017

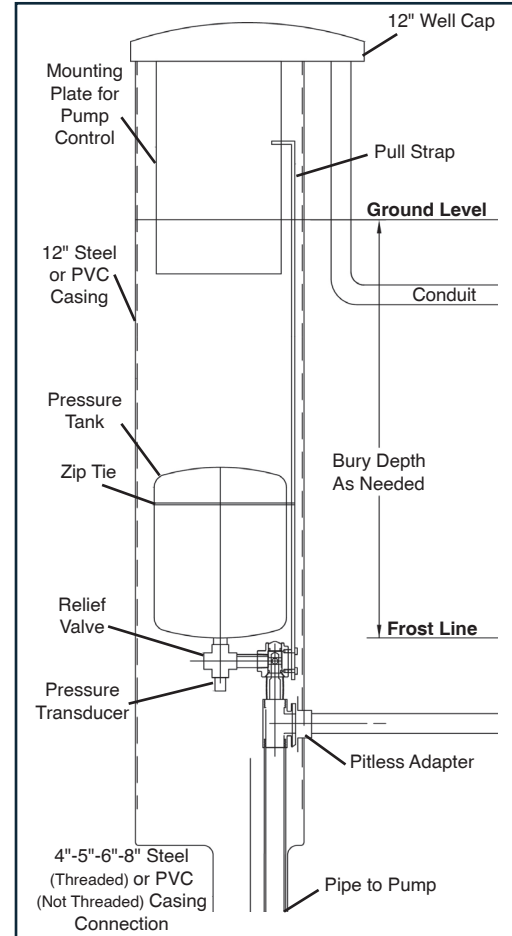

PCM for Variable Speed Pump  
Steel or PVC Casing



Control mounted on plate attached to lid



**Bottom of control units**  
Connects to 4" - 5" - 6" or 8"  
Steel or PVC casing

**Top of control units**  
12" casing contains everything - VFD  
- and Etc. along with expansion tank



Lifting with Pull  
Strap Steel Casing



PVC Casing with  
Pitless Adapter apart

U.S. Patent #  
6,592,342



 No-Lead

## 12" Galvanized Steel Upper Casing to 4" Well Casing

Order Number	UPC Bar Code (Qty.1)	Casing Size	Bury Depth	Discharge Size	Tank Size	Watertight Cap Included	Approx. Weight
<b>4" Casing Models</b>							
PCM4302U	6 42367 43949 1	4"	3'	1"	2.1 Gallon	With Plate	----
PCM4310U	6 42367 43950 7	4"	3'	1-1/4"	No Tank	With Plate	----
PCM4312U	6 42367 43951 4	4"	3'	1-1/4"	2.1 Gallon	With Plate	----
PCM4314U	6 42367 43952 1	4"	3'	1-1/4"	4.5 Gallon	With Plate	----
PCM4318U	6 42367 43953 8	4"	3'	1-1/4"	10 Gallon	With Plate	----
PCM4320U	6 42367 43954 5	4"	3'	2"	No Tank	With Plate	----
PCM4328U	6 42367 43955 2	4"	3'	2"	10 Gallon	With Plate	----
PCM4402U	6 42367 43956 9	4"	4'	1"	2.1 Gallon	With Plate	----
PCM4410U	6 42367 43880 7	4"	4'	1-1/4"	No Tank	With Plate	230.0
PCM4412U	6 42367 43734 3	4"	4'	1-1/4"	2.1 Gallon	With Plate	236.5
PCM4414U	6 42367 43735 0	4"	4'	1-1/4"	4.5 Gallon	With Plate	238.0
PCM4418U	6 42367 43736 7	4"	4'	1-1/4"	10 Gallon	With Plate	----
PCM4420U	6 42367 43901 9	4"	4'	2"	No Tank	With Plate	230.0
PCM4428U	6 42367 43737 4	4"	4'	2"	10 Gallon	With Plate	244.0
PCM4502U	6 42367 43957 6	4"	5'	1"	2.1 Gallon	With Plate	----
PCM4510U	6 42367 43881 4	4"	5'	1-1/4"	No Tank	With Plate	254.5
PCM4512U	6 42367 43738 1	4"	5'	1-1/4"	2.1 Gallon	With Plate	261.5
PCM4514U	6 42367 43739 8	4"	5'	1-1/4"	4.5 Gallon	With Plate	263.0
PCM4518U	6 42367 43740 4	4"	5'	1-1/4"	10 Gallon	With Plate	268.0
PCM4520U	6 42367 43902 6	4"	5'	2"	No Tank	With Plate	230.0
PCM4528U	6 42367 43741 1	4"	5'	2"	10 Gallon	With Plate	269.0
PCM4602U	6 42367 43958 3	4"	6'	1"	2.1 Gallon	With Plate	----
PCM4610U	6 42367 43959 0	4"	6'	1-1/4"	No Tank	With Plate	----
PCM4612U	6 42367 43960 6	4"	6'	1-1/4"	2.1 Gallon	With Plate	----
PCM4614U	6 42367 43961 3	4"	6'	1-1/4"	4.5 Gallon	With Plate	----
PCM4618U	6 42367 43962 0	4"	6'	1-1/4"	10 Gallon	With Plate	----
PCM4620U	6 42367 43963 7	4"	6'	2"	No Tank	With Plate	----
PCM4628U	6 42367 43964 4	4"	6'	2"	10 Gallon	With Plate	----
PCM4702U	6 42367 43965 1	4"	7'	1"	2.1 Gallon	With Plate	----
PCM4710U	6 42367 43966 8	4"	7'	1-1/4"	No Tank	With Plate	----
PCM4712U	6 42367 43967 5	4"	7'	1-1/4"	2.1 Gallon	With Plate	----
PCM4714U	6 42367 43968 2	4"	7'	1-1/4"	4.5 Gallon	With Plate	----
PCM4718U	6 42367 43969 9	4"	7'	1-1/4"	10 Gallon	With Plate	----
PCM4720U	6 42367 43970 5	4"	7'	2"	No Tank	With Plate	----
PCM4728U	6 42367 43971 2	4"	7'	2"	10 Gallon	With Plate	----

**NOTE:** Units come standard with an Aluminum Well Cap



Galvanized Steel Bottom Casing Threads



**WARNING:** This product meets Federal USA Drinking Water requirements but has not been specifically tested or approved as no-lead in the State of California.

# H2O PITLESS CONTROL

U.S. Patent #  
6,592,342



 No-Lead

## 12" Galvanized Steel Upper Casing to 5" Well Casing

Order Number	UPC Bar Code (Qty.1)	Casing Size	Bury Depth	Discharge Size	Tank Size	Watertight Cap Included	Approx. Weight
<b>5" Casing Models</b>							
PCM5302U	6 42367 44015 2	5"	3'	1"	2.1 Gallon	With Plate	----
PCM5310U	6 42367 44016 9	5"	3'	1-1/4"	No Tank	With Plate	----
PCM5312U	6 42367 44017 6	5"	3'	1-1/4"	2.1 Gallon	With Plate	----
PCM5314U	6 42367 44018 3	5"	3'	1-1/4"	4.5 Gallon	With Plate	----
PCM5318U	6 42367 44019 0	5"	3'	1-1/4"	10 Gallon	With Plate	----
PCM5320U	6 42367 44020 6	5"	3'	2"	No Tank	With Plate	----
PCM5328U	6 42367 44021 3	5"	3'	2"	10 Gallon	With Plate	----
PCM5402U	6 42367 44022 0	5"	4'	1"	2.1 Gallon	With Plate	----
PCM5410U	6 42367 43882 1	5"	4'	1-1/4"	No Tank	With Plate	237.0
PCM5412U	6 42367 43742 8	5"	4'	1-1/4"	2.1 Gallon	With Plate	229.0
PCM5414U	6 42367 43743 5	5"	4'	1-1/4"	4.5 Gallon	With Plate	229.0
PCM5418U	6 42367 43744 2	5"	4'	1-1/4"	10 Gallon	With Plate	233.0
PCM5420U	6 42367 43903 3	5"	4'	2"	No Tank	With Plate	231.0
PCM5428U	6 42367 43745 9	5"	4'	2"	10 Gallon	With Plate	244.0
PCM5502U	6 42367 44023 7	5"	5'	1"	2.1 Gallon	With Plate	----
PCM5510U	6 42367 43883 8	5"	5'	1-1/4"	No Tank	With Plate	255.5
PCM5512U	6 42367 43746 6	5"	5'	1-1/4"	2.1 Gallon	With Plate	----
PCM5514U	6 42367 43747 3	5"	5'	1-1/4"	4.5 Gallon	With Plate	264.0
PCM5518U	6 42367 43748 0	5"	5'	1-1/4"	10 Gallon	With Plate	269.0
PCM5520U	6 42367 43884 5	5"	5'	2"	No Tank	With Plate	267.0
PCM5528U	6 42367 43749 7	5"	5'	2"	10 Gallon	With Plate	280.0
PCM5602U	6 42367 44024 4	5"	6'	1"	2.1 Gallon	With Plate	----
PCM5610U	6 42367 44025 1	5"	6'	1-1/4"	No Tank	With Plate	280.0
PCM5612U	6 42367 43750 3	5"	6'	1-1/4"	2.1 Gallon	With Plate	280.0
PCM5614U	6 42367 43751 0	5"	6'	1-1/4"	4.5 Gallon	With Plate	264.0
PCM5618U	6 42367 43752 7	5"	6'	1-1/4"	10 Gallon	With Plate	----
PCM5620U	6 42367 44026 8	5"	6'	2"	No Tank	With Plate	----
PCM5628U	6 42367 43753 4	5"	6'	2"	10 Gallon	With Plate	----
PCM5702U	6 42367 44027 5	5"	7'	1"	2.1 Gallon	With Plate	----
PCM5710U	6 42367 44028 2	5"	7'	1-1/4"	No Tank	With Plate	----
PCM5712U	6 42367 44029 9	5"	7'	1-1/4"	2.1 Gallon	With Plate	----
PCM5714U	6 42367 44030 5	5"	7'	1-1/4"	4.5 Gallon	With Plate	----
PCM5718U	6 42367 44031 2	5"	7'	1-1/4"	10 Gallon	With Plate	----
PCM5720U	6 42367 44032 9	5"	7'	2"	No Tank	With Plate	----
PCM5728U	6 42367 44033 6	5"	7'	2"	10 Gallon	With Plate	----

**NOTE:** Units come standard with an Aluminum Well Cap



Galvanized Steel Bottom Casing Threads



 **WARNING:** This product meets Federal USA Drinking Water requirements but has not been specifically tested or approved as no-lead in the State of California.

U.S. Patent #  
6,592,342



No-Lead

## 12" Galvanized Steel Upper Casing to 6" Well Casing

Order Number	UPC Bar Code (Qty.1)	Casing Size	Bury Depth	Discharge Size	Tank Size	Watertight Cap Included	Approx. Weight
<b>6" Casing Models</b>							
PCM6302U	6 42367 43972 9	6"	3'	1"	2.1 Gallon	With Plate	----
PCM6310U	6 42367 43973 6	6"	3'	1-1/4"	No Tank	With Plate	----
PCM6312U	6 42367 43974 3	6"	3'	1-1/4"	2.1 Gallon	With Plate	----
PCM6314U	6 42367 43975 0	6"	3'	1-1/4"	4.5 Gallon	With Plate	----
PCM6318U	6 42367 43976 7	6"	3'	1-1/4"	10 Gallon	With Plate	----
PCM6320U	6 42367 43977 4	6"	3'	2"	No Tank	With Plate	----
PCM6328U	6 42367 43978 1	6"	3'	2"	10 Gallon	With Plate	----
PCM6402U	6 42367 43979 8	6"	4'	1"	2.1 Gallon	With Plate	----
PCM6410U	6 42367 43980 4	6"	4'	1-1/4"	No Tank	With Plate	----
PCM6412U	6 42367 43754 1	6"	4'	1-1/4"	2.1 Gallon	With Plate	----
PCM6414U	6 42367 43755 8	6"	4'	1-1/4"	4.5 Gallon	With Plate	260.0
PCM6418U	6 42367 43756 5	6"	4'	1-1/4"	10 Gallon	With Plate	----
PCM6420U	6 42367 43981 1	6"	4'	2"	No Tank	With Plate	----
PCM6428U	6 42367 43757 2	6"	4'	2"	10 Gallon	With Plate	----
PCM6502U	6 42367 43982 8	6"	5'	1"	2.1 Gallon	With Plate	----
PCM6510U	6 42367 43983 5	6"	5'	1-1/4"	No Tank	With Plate	----
PCM6512U	6 42367 43758 9	6"	5'	1-1/4"	2.1 Gallon	With Plate	----
PCM6514U	6 42367 43759 6	6"	5'	1-1/4"	4.5 Gallon	With Plate	260.0
PCM6518U	6 42367 43760 2	6"	5'	1-1/4"	10 Gallon	With Plate	276.9
PCM6520U	6 42367 43900 2	6"	5'	2"	No Tank	With Plate	255.5
PCM6528U	6 42367 43761 9	6"	5'	2"	10 Gallon	With Plate	281.0
PCM6602U	6 42367 43984 2	6"	6'	1"	2.1 Gallon	With Plate	----
PCM6610U	6 42367 43985 9	6"	6'	1-1/4"	No Tank	With Plate	----
PCM6612U	6 42367 43762 6	6"	6'	1-1/4"	2.1 Gallon	With Plate	290.0
PCM6614U	6 42367 43763 3	6"	6'	1-1/4"	4.5 Gallon	With Plate	290.0
PCM6618U	6 42367 43764 0	6"	6'	1-1/4"	10 Gallon	With Plate	----
PCM6620U	6 42367 43986 6	6"	6'	2"	No Tank	With Plate	306.0
PCM6628U	6 42367 43765 7	6"	6'	2"	10 Gallon	With Plate	306.0
PCM6702U	6 42367 43987 3	6"	7'	1"	2.1 Gallon	With Plate	----
PCM6710U	6 42367 43988 0	6"	7'	1-1/4"	No Tank	With Plate	254.5
PCM6712U	6 42367 43989 7	6"	7'	1-1/4"	2.1 Gallon	With Plate	----
PCM6714U	6 42367 43990 3	6"	7'	1-1/4"	4.5 Gallon	With Plate	----
PCM6718U	6 42367 43991 0	6"	7'	1-1/4"	10 Gallon	With Plate	----
PCM6720U	6 42367 43992 7	6"	7'	2"	No Tank	With Plate	----
PCM6728U	6 42367 43993 4	6"	7'	2"	10 Gallon	With Plate	----

**NOTE:** Units come standard with an Aluminum Well Cap



Galvanized Steel Bottom Casing Threads



**WARNING:** This product meets Federal USA Drinking Water requirements but has not been specifically tested or approved as no-lead in the State of California.

# H2O PITLESS CONTROL

U.S. Patent #  
6,592,342



No-Lead

## 12" Galvanized Steel Upper Casing to 8" Well Casing

Order Number	UPC Bar Code (Qty.1)	Casing Size	Bury Depth	Discharge Size	Tank Size	Watertight Cap Included	Approx. Weight
<b>8" Casing Models</b>							
PCM8312U	6 42367 43994 1	8"	3'	1-1/4"	2.1 Gallon	With Plate	----
PCM8314U	6 42367 43995 8	8"	3'	1-1/4"	4.5 Gallon	With Plate	----
PCM8318U	6 42367 43996 5	8"	3'	1-1/4"	10 Gallon	With Plate	----
PCM8322U	6 42367 43997 2	8"	3'	2"	2.1 Gallon	With Plate	----
PCM8324U	6 42367 43998 9	8"	3'	2"	4.5 Gallon	With Plate	----
PCM8328U	6 42367 43999 6	8"	3'	2"	10 Gallon	With Plate	----
PCM8412U	6 42367 43766 4	8"	4'	1-1/4"	2.1 Gallon	With Plate	----
PCM8414U	6 42367 43767 1	8"	4'	1-1/4"	4.5 Gallon	With Plate	----
PCM8418U	6 42367 43768 8	8"	4'	1-1/4"	10 Gallon	With Plate	----
PCM8422U	6 42367 44000 8	8"	4'	2"	2.1 Gallon	With Plate	----
PCM8424U	6 42367 44001 5	8"	4'	2"	4.5 Gallon	With Plate	320.0
PCM8428U	6 42367 43769 5	8"	4'	2"	10 Gallon	With Plate	----
PCM8512U	6 42367 43770 1	8"	5'	1-1/4"	2.1 Gallon	With Plate	----
PCM8514U	6 42367 43771 8	8"	5'	1-1/4"	4.5 Gallon	With Plate	----
PCM8518U	6 42367 43772 5	8"	5'	1-1/4"	10 Gallon	With Plate	----
PCM8522U	6 42367 44002 2	8"	5'	2"	2.1 Gallon	With Plate	----
PCM8524U	6 42367 44003 9	8"	5'	2"	4.5 Gallon	With Plate	----
PCM8528U	6 42367 43773 2	8"	5'	2"	10 Gallon	With Plate	320.0
PCM8612U	6 42367 44004 6	8"	6'	1-1/4"	2.1 Gallon	With Plate	----
PCM8614U	6 42367 44005 3	8"	6'	1-1/4"	4.5 Gallon	With Plate	----
PCM8618U	6 42367 44006 0	8"	6'	1-1/4"	10 Gallon	With Plate	----
PCM8622U	6 42367 44007 7	8"	6'	2"	2.1 Gallon	With Plate	----
PCM8624U	6 42367 44008 4	8"	6'	2"	4.5 Gallon	With Plate	----
PCM8628U	6 42367 44009 1	8"	6'	2"	10 Gallon	With Plate	----

**NOTE:** Units come standard with an Aluminum Well Cap



Galvanized Steel Casing shown featuring Stainless Steel components



Galvanized Steel Bottom Casing Threads

U.S. Patent #  
7,118,357



 No-Lead

## 12" PVC Upper Casing to 4" Well Casing

Order Number	UPC Bar Code (Qty.1)	Casing Size	Bury Depth	Discharge Size	Tank Size	Watertight Cap Included	Approx. Weight
<b>4" Casing Models</b>							
PPCM4302U	6 42367 43774 9	4"	3'	1"	2.1 Gallon	With Plate	90.0
PPCM4310U	6 42367 44041 1	4"	3'	1-1/4"	No Tank	With Plate	----
PPCM4312U	6 42367 43777 0	4"	3'	1-1/4"	2.1 Gallon	With Plate	----
PPCM4314U	6 42367 43778 7	4"	3'	1-1/4"	4.5 Gallon	With Plate	90.0
PPCM4318U	6 42367 43779 4	4"	3'	1-1/4"	10 Gallon	With Plate	----
PPCM4320U	6 42367 44042 8	4"	3'	2"	No Tank	With Plate	----
PPCM4328U	6 42367 43780 0	4"	3'	2"	10 Gallon	With Plate	----
PPCM4402U	6 42367 44043 5	4"	4'	1"	2.1 Gallon	With Plate	90.0
PPCM4410U	6 42367 44044 2	4"	4'	1-1/4"	No Tank	With Plate	----
PPCM4412U	6 42367 44045 9	4"	4'	1-1/4"	2.1 Gallon	With Plate	----
PPCM4414U	6 42367 44046 6	4"	4'	1-1/4"	4.5 Gallon	With Plate	90.0
PPCM4418U	6 42367 44047 3	4"	4'	1-1/4"	10 Gallon	With Plate	----
PPCM4420U	6 42367 44048 0	4"	4'	2"	No Tank	With Plate	----
PPCM4428U	6 42367 44049 7	4"	4'	2"	10 Gallon	With Plate	----
PPCM4502U	6 42367 44050 3	4"	5'	1"	2.1 Gallon	With Plate	----
PPCM4510U	6 42367 44051 0	4"	5'	1-1/4"	No Tank	With Plate	----
PPCM4512U	6 42367 44052 7	4"	5'	1-1/4"	2.1 Gallon	With Plate	----
PPCM4514U	6 42367 44053 4	4"	5'	1-1/4"	4.5 Gallon	With Plate	96.0
PPCM4518U	6 42367 44054 1	4"	5'	1-1/4"	10 Gallon	With Plate	----
PPCM4520U	6 42367 44055 8	4"	5'	2"	No Tank	With Plate	----
PPCM4528U	6 42367 44056 5	4"	5'	2"	10 Gallon	With Plate	----
PPCM4602U	6 42367 44057 2	4"	6'	1"	2.1 Gallon	With Plate	----
PPCM4610U	6 42367 44058 9	4"	6'	1-1/4"	No Tank	With Plate	----
PPCM4612U	6 42367 44059 6	4"	6'	1-1/4"	2.1 Gallon	With Plate	----
PPCM4614U	6 42367 44060 2	4"	6'	1-1/4"	4.5 Gallon	With Plate	----
PPCM4618U	6 42367 44061 9	4"	6'	1-1/4"	10 Gallon	With Plate	----
PPCM4620U	6 42367 44062 6	4"	6'	2"	No Tank	With Plate	----
PPCM4628U	6 42367 44063 3	4"	6'	2"	10 Gallon	With Plate	----
PPCM4702U	6 42367 44064 0	4"	7'	1"	2.1 Gallon	With Plate	90.0
PPCM4710U	6 42367 44065 7	4"	7'	1-1/4"	No Tank	With Plate	----
PPCM4712U	6 42367 44066 4	4"	7'	1-1/4"	2.1 Gallon	With Plate	----
PPCM4714U	6 42367 44067 1	4"	7'	1-1/4"	4.5 Gallon	With Plate	----
PPCM4718U	6 42367 44068 8	4"	7'	1-1/4"	10 Gallon	With Plate	----
PPCM4720U	6 42367 44069 5	4"	7'	2"	No Tank	With Plate	----
PPCM4728U	6 42367 44070 1	4"	7'	2"	10 Gallon	With Plate	----

**NOTE:** Units come standard with an Aluminum Well Cap



**WARNING:** This product meets Federal USA Drinking Water requirements but has not been specifically tested or approved as no-lead in the State of California.

# H2O PITLESS CONTROL

U.S. Patent #  
7,118,357



 No-Lead

## 12" PVC Upper Casing to 5" Well Casing

Order Number	UPC Bar Code (Qty.1)	Casing Size	Bury Depth	Discharge Size	Tank Size	Watertight Cap Included	Approx. Weight
<b>5" Casing Models</b>							
PPCM5302U	6 42367 43781 7	5"	3'	1"	2.1 Gallon	With Plate	90.0
PPCM5310U	6 42367 44071 8	5"	3'	1-1/4"	No Tank	With Plate	90.0
PPCM5312U	6 42367 43784 8	5"	3'	1-1/4"	2.1 Gallon	With Plate	----
PPCM5314U	6 42367 43785 5	5"	3'	1-1/4"	4.5 Gallon	With Plate	----
PPCM5318U	6 42367 43786 2	5"	3'	1-1/4"	10 Gallon	With Plate	90.0
PPCM5320U	6 42367 44072 5	5"	3'	2"	No Tank	With Plate	90.0
PPCM5328U	6 42367 43787 9	5"	3'	2"	10 Gallon	With Plate	----
PPCM5402U	6 42367 44073 2	5"	4'	1"	2.1 Gallon	With Plate	229.0
PPCM5410U	6 42367 44074 9	5"	4'	1-1/4"	No Tank	With Plate	90.0
PPCM5412U	6 42367 44075 6	5"	4'	1-1/4"	2.1 Gallon	With Plate	90.0
PPCM5414U	6 42367 44076 3	5"	4'	1-1/4"	4.5 Gallon	With Plate	90.0
PPCM5418U	6 42367 44077 0	5"	4'	1-1/4"	10 Gallon	With Plate	----
PPCM5420U	6 42367 44078 7	5"	4'	2"	No Tank	With Plate	----
PPCM5428U	6 42367 44079 4	5"	4'	2"	10 Gallon	With Plate	90.0
PPCM5502U	6 42367 44080 0	5"	5'	1"	2.1 Gallon	With Plate	90.0
PPCM5510U	6 42367 44081 7	5"	5'	1-1/4"	No Tank	With Plate	90.0
PPCM5512U	6 42367 44082 4	5"	5'	1-1/4"	2.1 Gallon	With Plate	95.8
PPCM5514U	6 42367 44083 1	5"	5'	1-1/4"	4.5 Gallon	With Plate	90.0
PPCM5518U	6 42367 44085 5	5"	5'	1-1/4"	10 Gallon	With Plate	90.0
PPCM5520U	6 42367 44086 2	5"	5'	2"	No Tank	With Plate	90.0
PPCM5528U	6 42367 44087 9	5"	5'	2"	10 Gallon	With Plate	90.0
PPCM5602U	6 42367 44088 6	5"	6'	1"	2.1 Gallon	With Plate	----
PPCM5610U	6 42367 44089 3	5"	6'	1-1/4"	No Tank	With Plate	96.6
PPCM5612U	6 42367 44090 9	5"	6'	1-1/4"	2.1 Gallon	With Plate	----
PPCM5614U	6 42367 44091 6	5"	6'	1-1/4"	4.5 Gallon	With Plate	----
PPCM5618U	6 42367 44092 3	5"	6'	1-1/4"	10 Gallon	With Plate	----
PPCM5620U	6 42367 44093 0	5"	6'	2"	No Tank	With Plate	----
PPCM5628U	6 42367 44094 7	5"	6'	2"	10 Gallon	With Plate	121.2
PPCM5702U	6 42367 44095 4	5"	7'	1"	2.1 Gallon	With Plate	169.1
PPCM5710U	6 42367 44096 1	5"	7'	1-1/4"	No Tank	With Plate	----
PPCM5712U	6 42367 44097 8	5"	7'	1-1/4"	2.1 Gallon	With Plate	----
PPCM5714U	6 42367 44098 5	5"	7'	1-1/4"	4.5 Gallon	With Plate	----
PPCM5718U	6 42367 44100 5	5"	7'	1-1/4"	10 Gallon	With Plate	175.7
PPCM5720U	6 42367 44101 2	5"	7'	2"	No Tank	With Plate	----
PPCM5728U	6 42367 44102 9	5"	7'	2"	10 Gallon	With Plate	----

**NOTE:** Units come standard with an Aluminum Well Cap



**WARNING:** This product meets Federal USA Drinking Water requirements but has not been specifically tested or approved as no-lead in the State of California.

U.S. Patent #  
7,118,357



No-Lead

## 12" PVC Upper Casing to 6" Well Casing

Order Number	UPC Bar Code (Qty.1)	Casing Size	Bury Depth	Discharge Size	Tank Size	Watertight Cap Included	Approx. Weight
<b>6" Casing Models</b>							
PPCM6302U	6 42367 43788 6	6"	3'	1"	2.1 Gallon	With Plate	90.0
PPCM6310U	6 42367 44103 6	6"	3'	1-1/4"	No Tank	With Plate	71.5
PPCM6312U	6 42367 43791 6	6"	3'	1-1/4"	2.1 Gallon	With Plate	----
PPCM6314U	6 42367 43792 3	6"	3'	1-1/4"	4.5 Gallon	With Plate	----
PPCM6318U	6 42367 43793 0	6"	3'	1-1/4"	10 Gallon	With Plate	90.0
PPCM6320U	6 42367 44104 3	6"	3'	2"	No Tank	With Plate	90.0
PPCM6328U	6 42367 43794 7	6"	3'	2"	10 Gallon	With Plate	----
PPCM6402U	6 42367 44105 0	6"	4'	1"	2.1 Gallon	With Plate	90.0
PPCM6410U	6 42367 44106 7	6"	4'	1-1/4"	No Tank	With Plate	----
PPCM6412U	6 42367 44107 4	6"	4'	1-1/4"	2.1 Gallon	With Plate	90.0
PPCM6414U	6 42367 44108 1	6"	4'	1-1/4"	4.5 Gallon	With Plate	----
PPCM6418U	6 42367 44109 8	6"	4'	1-1/4"	10 Gallon	With Plate	----
PPCM6420U	6 42367 44110 4	6"	4'	2"	No Tank	With Plate	----
PPCM6428U	6 42367 44111 1	6"	4'	2"	10 Gallon	With Plate	----
PPCM6502U	6 42367 44112 8	6"	5'	1"	2.1 Gallon	With Plate	----
PPCM6510U	6 42367 44113 5	6"	5'	1-1/4"	No Tank	With Plate	----
PPCM6512U	6 42367 44114 2	6"	5'	1-1/4"	2.1 Gallon	With Plate	----
PPCM6514U	6 42367 44115 9	6"	5'	1-1/4"	4.5 Gallon	With Plate	----
PPCM6518U	6 42367 44116 6	6"	5'	1-1/4"	10 Gallon	With Plate	----
PPCM6520U	6 42367 44117 3	6"	5'	2"	No Tank	With Plate	----
PPCM6528U	6 42367 44118 0	6"	5'	2"	10 Gallon	With Plate	114.0
PPCM6602U	6 42367 44119 7	6"	6'	1"	2.1 Gallon	With Plate	----
PPCM6610U	6 42367 44120 3	6"	6'	1-1/4"	No Tank	With Plate	90.0
PPCM6612U	6 42367 44121 0	6"	6'	1-1/4"	2.1 Gallon	With Plate	104.9
PPCM6614U	6 42367 44122 7	6"	6'	1-1/4"	4.5 Gallon	With Plate	----
PPCM6618U	6 42367 44123 4	6"	6'	1-1/4"	10 Gallon	With Plate	----
PPCM6620U	6 42367 44124 1	6"	6'	2"	No Tank	With Plate	107.8
PPCM6628U	6 42367 44125 8	6"	6'	2"	10 Gallon	With Plate	90.0
PPCM6702U	6 42367 44126 5	6"	7'	1"	2.1 Gallon	With Plate	----
PPCM6710U	6 42367 44127 2	6"	7'	1-1/4"	No Tank	With Plate	----
PPCM6712U	6 42367 44128 9	6"	7'	1-1/4"	2.1 Gallon	With Plate	----
PPCM6714U	6 42367 44129 6	6"	7'	1-1/4"	4.5 Gallon	With Plate	----
PPCM6718U	6 42367 44130 2	6"	7'	1-1/4"	10 Gallon	With Plate	----
PPCM6720U	6 42367 44131 9	6"	7'	2"	No Tank	With Plate	----
PPCM6728U	6 42367 44132 6	6"	7'	2"	10 Gallon	With Plate	----

**NOTE:** Units come standard with an Aluminum Well Cap



**WARNING:** This product meets Federal USA Drinking Water requirements but has not been specifically tested or approved as no-lead in the State of California.

























# H2O PITLESS CONTROL

U.S. Patent #  
7,118,357



 No-Lead

## 12" PVC Upper Casing to 8" Well Casing

Order Number	UPC Bar Code (Qty.1)	Casing Size	Bury Depth	Discharge Size	Tank Size	Watertight Cap Included	Approx. Weight
<b>8" Casing Models</b>							
 PPCM8312U	6 42367 43806 7	8"	3'	1-1/4"	2.1 Gallon	With Plate	90.0
 PPCM8314U	6 42367 43807 4	8"	3'	1-1/4"	4.5 Gallon	With Plate	----
 PPCM8318U	6 42367 43808 1	8"	3'	1-1/4"	10 Gallon	With Plate	----
 PPCM8322U	6 42367 44133 3	8"	3'	2"	2.1 Gallon	With Plate	----
 PPCM8324U	6 42367 44134 0	8"	3'	2"	4.5 Gallon	With Plate	90.0
 PPCM8328U	6 42367 43809 8	8"	3'	2"	10 Gallon	With Plate	90.0
<hr/>							
 PPCM8412U	6 42367 44135 7	8"	4'	1-1/4"	2.1 Gallon	With Plate	----
 PPCM8414U	6 42367 44136 4	8"	4'	1-1/4"	4.5 Gallon	With Plate	----
 PPCM8418U	6 42367 44137 1	8"	4'	1-1/4"	10 Gallon	With Plate	----
 PPCM8422U	6 42367 44138 5	8"	4'	2"	2.1 Gallon	With Plate	----
 PPCM8424U	6 42367 44139 5	8"	4'	2"	4.5 Gallon	With Plate	----
 PPCM8428U	6 42367 44140 1	8"	4'	2"	10 Gallon	With Plate	----
<hr/>							
 PPCM8512U	6 42367 44141 8	8"	5'	1-1/4"	2.1 Gallon	With Plate	----
 PPCM8514U	6 42367 44142 5	8"	5'	1-1/4"	4.5 Gallon	With Plate	----
 PPCM8518U	6 42367 44143 2	8"	5'	1-1/4"	10 Gallon	With Plate	----
 PPCM8522U	6 42367 44144 9	8"	5'	2"	2.1 Gallon	With Plate	----
 PPCM8524U	6 42367 44145 6	8"	5'	2"	4.5 Gallon	With Plate	----
 PPCM8528U	6 42367 44146 3	8"	5'	2"	10 Gallon	With Plate	----
<hr/>							
 PPCM8612U	6 42367 44147 0	8"	6'	1-1/4"	2.1 Gallon	With Plate	----
 PPCM8614U	6 42367 44148 7	8"	6'	1-1/4"	4.5 Gallon	With Plate	----
 PPCM8618U	6 42367 44149 4	8"	6'	1-1/4"	10 Gallon	With Plate	----
 PPCM8622U	6 42367 44150 0	8"	6'	2"	2.1 Gallon	With Plate	----
 PPCM8624U	6 42367 44151 7	8"	6'	2"	4.5 Gallon	With Plate	----
 PPCM8628U	6 42367 44152 4	8"	6'	2"	10 Gallon	With Plate	----

**NOTE:** Units come standard with an Aluminum Well Cap



**WARNING:** This product meets Federal USA Drinking Water requirements but has not been specifically tested or approved as no-lead in the State of California.

## H2O PITLESS CONTROL CENTERS

### 12" PVC Upper Casing - Open Bottom Installed Outside Wall



No-Lead

Order Number	UPC Bar Code (Qty.1)	Bury Depth	Discharge Size	Tank Size	Watertight Cap Included	Approx. Weight
PPCC12302U	6 42367 44167 8	3'	1"	2.1 Gallon	With Plate	----
PPCC12310U	6 42367 44168 5	3'	1-1/4"	No Tank	With Plate	----
PPCC12312U	6 42367 44169 2	3'	1-1/4"	2.1 Gallon	With Plate	----
PPCC12314U	6 42367 44170 8	3'	1-1/4"	4.5 Gallon	With Plate	----
PPCC12318U	6 42367 44171 5	3'	1-1/4"	10 Gallon	With Plate	----
PPCC12320U	6 42367 44172 2	3'	2"	No Tank	With Plate	----
PPCC12328U	6 42367 44173 9	3'	2"	10 Gallon	With Plate	----
PPCC12402U	6 42367 44174 6	4'	1"	2.1 Gallon	With Plate	----
PPCC12410U	6 42367 44175 3	4'	1-1/4"	No Tank	With Plate	----
PPCC12412U	6 42367 44176 0	4'	1-1/4"	2.1 Gallon	With Plate	----
PPCC12414U	6 42367 44177 7	4'	1-1/4"	4.5 Gallon	With Plate	----
PPCC12418U	6 42367 44178 4	4'	1-1/4"	10 Gallon	With Plate	----
PPCC12420U	6 42367 44179 7	4'	2"	No Tank	With Plate	----
PPCC12428U	6 42367 44180 7	4'	2"	10 Gallon	With Plate	----
PPCC12502U	6 42367 44181 4	5'	1"	2.1 Gallon	With Plate	----
PPCC12510U	6 42367 44182 1	5'	1-1/4"	No Tank	With Plate	----
PPCC12512U	6 42367 44183 8	5'	1-1/4"	2.1 Gallon	With Plate	----
PPCC12514U	6 42367 44184 5	5'	1-1/4"	4.5 Gallon	With Plate	----
PPCC12518U	6 42367 44185 2	5'	1-1/4"	10 Gallon	With Plate	----
PPCC12520U	6 42367 44186 9	5'	2"	No Tank	With Plate	----
PPCC12528U	6 42367 44187 6	5'	2"	10 Gallon	With Plate	----
PPCC12602U	6 42367 44188 3	6'	1"	2.1 Gallon	With Plate	----
PPCC12610U	6 42367 44189 0	6'	1-1/4"	No Tank	With Plate	----
PPCC12612U	6 42367 44190 6	6'	1-1/4"	2.1 Gallon	With Plate	----
PPCC12614U	6 42367 44191 3	6'	1-1/4"	4.5 Gallon	With Plate	----
PPCC12618U	6 42367 44192 0	6'	1-1/4"	10 Gallon	With Plate	----
PPCC12620U	6 42367 44193 7	6'	2"	No Tank	With Plate	----
PPCC12628U	6 42367 44194 4	6'	2"	10 Gallon	With Plate	----
PPCC12702U	6 42367 44195 1	7'	1"	2.1 Gallon	With Plate	----
PPCC12710U	6 42367 44196 8	7'	1-1/4"	No Tank	With Plate	----
PPCC12712U	6 42367 44197 5	7'	1-1/4"	2.1 Gallon	With Plate	----
PPCC12714U	6 42367 44198 2	7'	1-1/4"	4.5 Gallon	With Plate	----
PPCC12718U	6 42367 44199 9	7'	1-1/4"	10 Gallon	With Plate	----
PPCC12720U	6 42367 44200 2	7'	2"	No Tank	With Plate	----
PPCC12728U	6 42367 44201 9	7'	2"	10 Gallon	With Plate	----



12" Aluminum Well Cap with Mounting Plate



Examples of Drive Pump Controls that may be mounted to plate

# H2O PITLESS UNIT COMPONENTS

## AT THE WELL PRESSURE SWITCH CONTROL

### INCLUDED IN KIT:

- Pressure Switch Bracket - Bolts to Pull Coupling
- All Fittings Needed to Connect Pressure Switch
- Tubing and Clamps to Connect Pressure Switch
- Cycle Stop Valve - Directly Below Pitless Adapter
- Merrill MPSXHD Pressure Switch or Merrill MCSHD Control Switch Puts Control Box + Pressure Switch Together

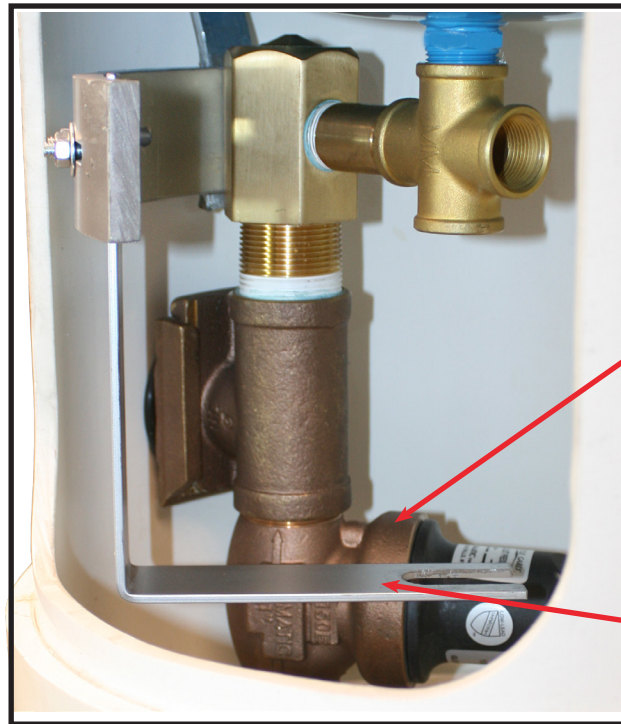

Cycle Stop Valve  
Directly  
Below Pitless  
Adapter

Pressure  
Switch  
Bracket

### FEATURES AND BENEFITS

- A** Bracket for Mounting Pressure Switch
- B** Provides easy installation of pressure switch inside the H2O Unit
- C** The pressure switch is below the tank and is still easily removed with tank when needed
- D** Expansion tank, fittings, piping connections, and cycle stop valve included and pressure switch to complete installation of pump control and provides serviceability
- E** Easiest low cost answer
- F** Everything fits inside 12" casing

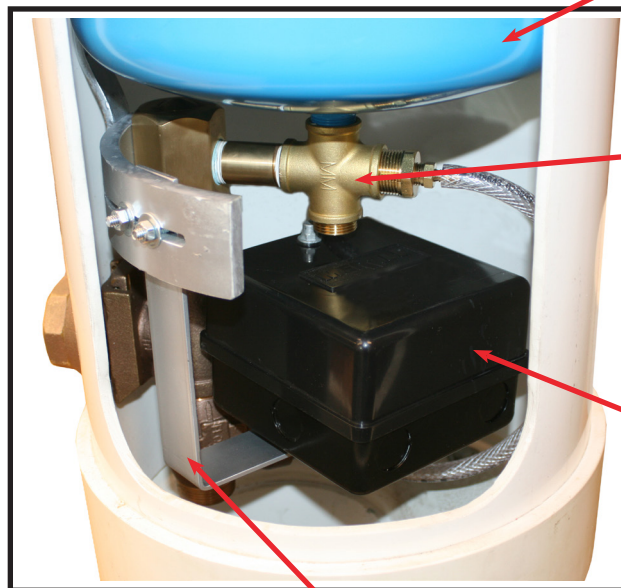

Pressure  
Tank

No-Lead  
Brass  
Cross

Merrill  
Pressure  
Switch or  
Control  
Switch

H2O Bracket with  
Pressure Switch or Control  
Switch installed

# H2O PITLESS UNIT COMPONENTS FOR AT THE WELL PRESSURE SWITCH CONTROL

## H2O At the Well Pressure Switch Control Parts List



No-Lead

Order Number	UPC Bar Code (Qty.1)	Description
H2PSB	6 42367 45349 7	Pressure Switch Bracket
H2PSFS	6 42367 45350 3	Fittings to Connect Pressure Switch
H2TAC	6 42367 45351 0	Tubing and Clamps to Connect Fittings
H2CSV	6 42367 45352 7	Cycle Stop Valve Install Below Pitless Adapter
1/4"IDTUBE	6 42367 45445 6	1/4" Inside Diameter Braided Vinyl Tubing
RBNLHB7525	6 42367 45446 3	3/4" x 1/4" No Lead Red Brass Hex Bushing
MPSXHD	----	Merrill MPSXHD Pressure Switch (not included)
MCSHD	----	Merrill MCSHD Control Switch (not included)

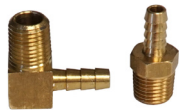

H2PSFS



H2TAC

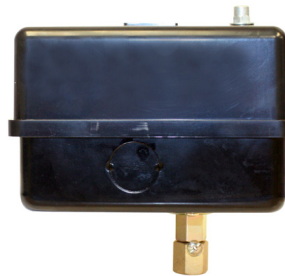

Merrill MPSXHD Pressure Switch



H2PSB

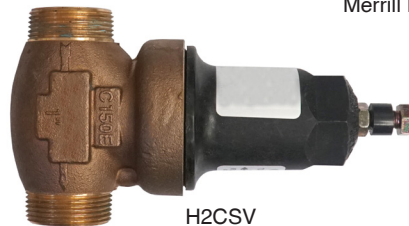

H2CSV



Merrill MCSHD Control Switch

### Merrill H2O Pressure Switch Control Package Includes:

Order No. **H2OPSCP** UPC Bar Code 6 42367 45453 1

- No-Lead Brass Bushing (Part No. H2PSFS)
- No-Lead Brass Fittings (Part No. H2PSFS)
- Reinforced Tubing and Stainless Steel Clamps (Part No. H2TAC)
- Pressure Switch Bracket (Part No. H2PSB)
- Cycle Stop Valve (Part No. H2CSV)

**NOTE: This Package is to be used with a 10 gallon tank or larger**

The H2O Pressure Switch Control is recommended to be used with Merrill MPSXHD Pressure Switch or Merrill MCSHD Control Switch that eliminates the control box.

MPSXHD Switches - Are rated up to 5HP

MCSHD Control Switches - Are rated up to 5HP

# H2O PITLESS CONTROL

## PARTS AND ACCESSORIES

### H2O Parts List



No-Lead

Order Number	UPC Bar Code (Qty.1)	Description
H2BVFNL	6 42367 43863 0	2" Hex No Lead Brass Female Valve
H2BVF12SS	6 42367 45494 4	Stainless Steel Female Valve
H2BVMNL100	6 42367 43866 1	1" Pull Pipe No Lead Brass Male Valve
H2BVMNL125	6 42367 43865 4	1-1/4" Pull Pipe No Lead Brass Male Valve
H2BVM125SS	6 42367 45495 1	1-1/4" Pull Pipe Stainless Steel Male Valve
OR210	6 42367 43853 1	#210 O-Ring
STRAP27	6 42367 43832 6	1/4" x 1" x 27" Pull Strap
STRAP41	6 42367 43833 3	1/4" x 1" x 41" Pull Strap
STRAP53	6 42367 43834 0	1/4" x 1" x 53" Pull Strap
STRAP65	6 42367 43835 7	1/4" x 1" x 65" Pull Strap
STRAP77	6 42367 43836 4	1/4" x 1" x 77" Pull Strap
WCH12T	6 42367 43888 3	12" Aluminum Well Cap Cover
WCH12B	6 42367 43889 0	12" Aluminum Bottom Ring
H2UP	6 42367 43855 5	Aluminum Universal Plate
WCH1200	6 42367 43886 9	12" Well Cap and Bottom Ring Unit (Tapped for mounting plate)
WCH1200UB	6 42367 43890 6	12" Well Cap and Bottom Ring with Mounting Plate
OR457	6 42367 43816 6	12" Cover O-Ring
OR454	6 42367 43815 9	12" Bottom Ring O-Ring
MBNL200D	6 42367 43891 3	MBNL200 1" Discharge
MHBNL125D	6 42367 44657 4	MHBNL125 Heavy-Duty 1-1/4" Discharge
SSMB125H2	6 42367 45496 8	Heavy-Duty Stainless Steel 1-1/4" Pitless Adapter
MBNL300D	6 42367 43893 7	MBNL300 2" Discharge
BPNL25	6 42367 43824 1	1/4" No Lead Brass Plug with Square Head
BNNL75025	6 42367 43879 1	3/4" x 2-1/2" No Lead Brass Nipple
SSN75015	6 42367 45497 5	3/4" x 1-1/2" Stainless Steel Nipple
BCNL75	6 42367 43823 4	3/4" No Lead Brass Cross
SSCT75	6 42367 45430 2	3/4" Stainless Steel Cross
H2PT2	6 42367 43896 8	2.1 Gallon Pressure Tank
H2PT4	6 42367 43897 5	4.5 Gallon Pressure Tank
H2PT10	6 42367 44385 6	10 Gallon Pressure Tank
C5	6 42367 09463 8	Stainless Steel Pull Strap Bolt 1/4" x 1/2"
3/4SCREEN	6 42367 05121 1	Vent Screen
GGS1/4	6 42367 01602 9	Green Ground Screw
SS1/4X5/8HCS	6 42367 41182 4	Stainless Steel Ring Bolt
SS1/2X1-1/2	6 42367 41989 9	Stainless Steel Lid Bolt
SS1/4HN	6 42367 43854 8	Stainless Steel 1/4-20 Hex Nut

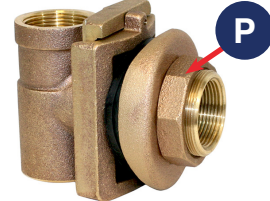
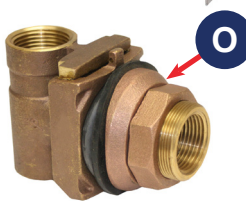
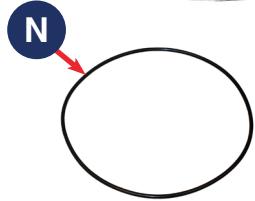
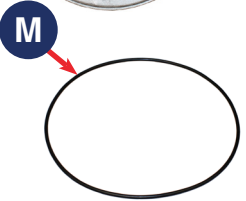
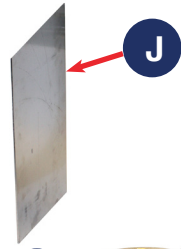
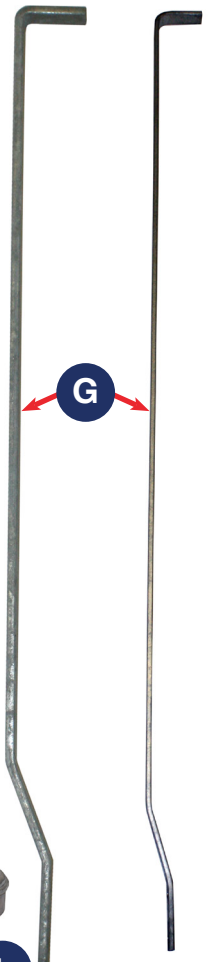
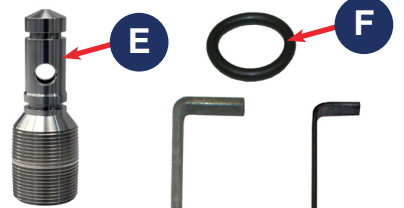
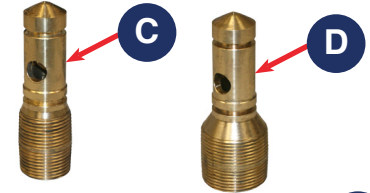
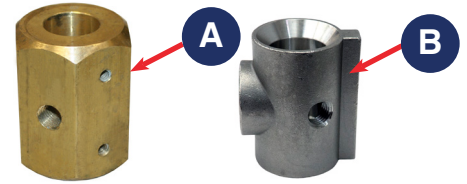

- A Part Number: H2BVFNL**  
2" Hex No Lead Brass Female Valve
- B Part Number: H2BVF12SS**  
Stainless Steel Female Valve
- C Part Number: H2BVMNL100**  
1" Pull Pipe No Lead Brass Male Valve
- D Part Number: H2BVMNL125**  
1-1/4" Pull Pipe No Lead Brass Male Valve
- E Part Number: H2BVM125SS**  
1-1/4" Pull Pipe Stainless Steel Male Valve
- F Part Number: OR210**  
#210 O-Ring
- G Part Number: STRAP27/  
STRAP41**  
1/4" x 1" x 27" Pull Strap  
Also 41", 53", 65", 77" Long
- H Part Number: WCH12T**  
12" Aluminum Well Cap Cover
- I Part Number: WCH12B**  
12" Aluminum Bottom Ring
- J Part Number: H2UP**  
Aluminum Universal Plate
- K Part Number: WCH1200**  
12" Well Cap and Bottom Ring Unit
- L Part Number: WCH1200UB**  
12" Well Cap, Bottom Ring, with  
Mounting Plate
- M Part Number: OR457**  
12" Cover O-Ring
- N Part Number: OR454**  
12" Bottom Ring O-Ring
- O Part Number: MBNL200D**  
MBNL200 1" Discharge
- P Part Number: MHBNL125D**  
MHBNL125 Heavy-Duty  
1-1/4" Discharge

- Q Part Number: SSMB125H2**  
Heavy-Duty Stainless Steel 1-1/4"  
Pitless Adapter
- R Part Number: MBNL300D**  
MBNL300 2" Discharge
- S Part Number: BPNL25**  
1/4" No Lead Brass Plug with  
Square Head
- T Part Number: BNBL75025**  
3/4" x 2-1/2" No Lead Brass  
Nipple
- U Part Number: SSN75015**  
3/4" x 1-1/2" Stainless Steel  
Nipple
- V Part Number: BCNL75**  
3/4" No Lead Brass Cross
- W Part Number: SSCT75**  
3/4" Stainless Steel Cross
- X Part Number: H2PT2**  
2.1 Gallon Pressure Tank
- Y Part Number: H2PT4**  
4.5 Gallon Pressure Tank
- Z Part Number: H2PT10**  
10 Gallon Pressure Tank
- Aa Part Number: C-5**  
Stainless Steel Pull Strap Bolt  
1/4" x 1/2"
- Bb Part Number: 3/4SCREEN**  
Vent Screen
- Cc Part Number: GGS1/4**  
Green Ground Screw
- Dd Part Number: SS1/4X5/8HCS**  
Stainless Steel Ring Bolt
- Ee Part Number: SS1/4X1-1/2**  
Stainless Steel Lid Bolt
- Ff Part Number: SS1/4HN**  
Stainless Steel 1/4-20 Hex Nut

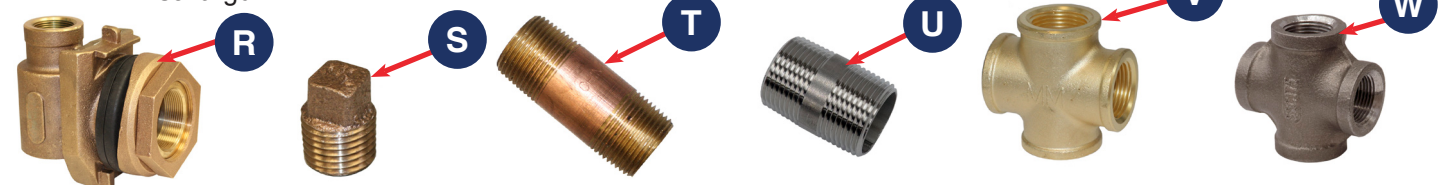



© 2024 Merrill Manufacturing Form No. 2114.13  
315 Flindt Dr. | Storm Lake, Iowa 50588 | (800) 831-6962 | [merrillmfg.com](http://merrillmfg.com)