

H2O PITLESS CONTROL UNITS

Galvanized Steel or PVC



LEARN MORE ABOUT THE BEST IN THE INDUSTRY AT merrillmfg.com

H2O PITLESS CONTROL

FEATURES AND BENEFITS

- A Connects to 4", 5", 6", or 8" steel or PVC well casing**
Benefit - Easy attachment to the casing - sizes you need.
- B Constant pressure controls can be mounted at the well**
Benefit - One universal plate holds VFD drive or all USA Pump Co., and VFD drive is now protected inside top of the well, out of the weather.
- C 12" Pipe in galvanized steel or PVC at top of well contains everything**
Benefit - All needed connections for controls are designed to fit inside a 12" casing - compact installation.
- D Expansion tank included inside H2O pitless control units**
Benefit - Small tank recommended for VFD drive installations is included with the H2O pitless control unit.
- E Internal manifold of unit has pull strap for easy removal to service well**
Benefit - No special pulling tool needed for service work - pulling strap built in.
- F Internal manifold of unit has tappings for expansion tank, pressure transducer, pressure relief valve, and pressure gauge**
Benefit - Minimum work required to complete the installation - all needed tappings included.
- G Stainless steel waterways, pitless adapter, and internal manifold**
Benefit - In compliance with safe water drinking act for residential drinking water supply.
- H Universal aluminum VFD mounting plate attached to top lid of watertight cap**
Benefit - VFD drive easily mounted for at the well control and out of the weather.
- I Approved by Wisconsin DNR and Minnesota Department of Health several other states (code approved)**
Benefit - Most all states that require a product to be code approved have approved the H2O pitless control unit.



Control mounted on plate attached to lid



Bottom of control units
Connects to 4" - 5" - 6" or 8"
Steel or PVC casing

Top of control units
12" casing contains everything - VFD
- and Etc. along with expansion tank

Since 2017

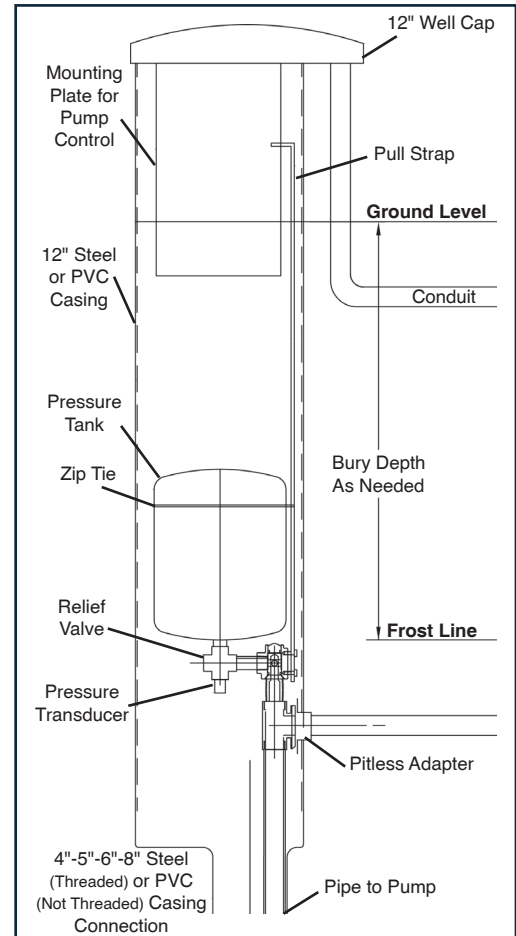

PCM for Variable Speed Pump
Steel or PVC Casing



Lifting with Pull
Strap Steel Casing



PVC Casing with
Pitless Adapter apart

U.S. Patent #
6,592,342



 No-Lead

12" Galvanized Steel Upper Casing to 4" Well Casing

Order Number	UPC Bar Code (Qty.1)	Casing Size	Bury Depth	Discharge Size	Tank Size	Watertight Cap Included	Approx. Weight
4" Casing Models							
PCM4302U	6 42367 43949 1	4"	3'	1"	2.1 Gallon	With Plate	----
PCM4310U	6 42367 43950 7	4"	3'	1-1/4"	No Tank	With Plate	----
PCM4312U	6 42367 43951 4	4"	3'	1-1/4"	2.1 Gallon	With Plate	----
PCM4314U	6 42367 43952 1	4"	3'	1-1/4"	4.5 Gallon	With Plate	----
PCM4318U	6 42367 43953 8	4"	3'	1-1/4"	6 Gallon	With Plate	----
PCM4402U	6 42367 43956 9	4"	4'	1"	2.1 Gallon	With Plate	----
PCM4410U	6 42367 43880 7	4"	4'	1-1/4"	No Tank	With Plate	230.0
PCM4412U	6 42367 43734 3	4"	4'	1-1/4"	2.1 Gallon	With Plate	236.5
PCM4414U	6 42367 43735 0	4"	4'	1-1/4"	4.5 Gallon	With Plate	238.0
PCM4418U	6 42367 43736 7	4"	4'	1-1/4"	6 Gallon	With Plate	----
PCM4502U	6 42367 43957 6	4"	5'	1"	2.1 Gallon	With Plate	----
PCM4510U	6 42367 43881 4	4"	5'	1-1/4"	No Tank	With Plate	254.5
PCM4512U	6 42367 43738 1	4"	5'	1-1/4"	2.1 Gallon	With Plate	261.5
PCM4514U	6 42367 43739 8	4"	5'	1-1/4"	4.5 Gallon	With Plate	263.0
PCM4518U	6 42367 43740 4	4"	5'	1-1/4"	6 Gallon	With Plate	268.0
PCM4602U	6 42367 43958 3	4"	6'	1"	2.1 Gallon	With Plate	----
PCM4610U	6 42367 43959 0	4"	6'	1-1/4"	No Tank	With Plate	----
PCM4612U	6 42367 43960 6	4"	6'	1-1/4"	2.1 Gallon	With Plate	----
PCM4614U	6 42367 43961 3	4"	6'	1-1/4"	4.5 Gallon	With Plate	----
PCM4618U	6 42367 43962 0	4"	6'	1-1/4"	6 Gallon	With Plate	----
PCM4702U	6 42367 43965 1	4"	7'	1"	2.1 Gallon	With Plate	----
PCM4710U	6 42367 43966 8	4"	7'	1-1/4"	No Tank	With Plate	----
PCM4712U	6 42367 43967 5	4"	7'	1-1/4"	2.1 Gallon	With Plate	----
PCM4714U	6 42367 43968 2	4"	7'	1-1/4"	4.5 Gallon	With Plate	----
PCM4718U	6 42367 43969 9	4"	7'	1-1/4"	6 Gallon	With Plate	----

NOTE: Units come standard with an Aluminum Well Cap
- May order without an Aluminum Well Cap - Call for Price

Extras for Easier & Better Installation (see Parts List)

- APC Pitless Connectors (Ductile Iron) - APC4, APC5, APC6
- APCGI Pitless Connectors (Gray Iron) - APC6GI
- Anti-Seize/Gasket Lube - PAL100



 **WARNING:** This product can expose you to lead, which is known to the State of California to cause cancer, birth defects or other reproductive harm. For more information go to www.P65Warnings.ca.gov

 **WARNING:** This product meets Federal USA Drinking Water requirements but has not been specifically tested or approved as no-lead in the State of California.



Galvanized Steel Bottom Casing Threads

H2O PITLESS CONTROL

12" Galvanized Steel Upper Casing to 5" Well Casing

U.S. Patent #
6,592,342



 No-Lead

Order Number	UPC Bar Code (Qty.1)	Casing Size	Bury Depth	Discharge Size	Tank Size	Watertight Cap Included	Approx. Weight
5" Casing Models							
PCM5302U	6 42367 44015 2	5"	3'	1"	2.1 Gallon	With Plate	----
PCM5310U	6 42367 44016 9	5"	3'	1-1/4"	No Tank	With Plate	----
PCM5312U	6 42367 44017 6	5"	3'	1-1/4"	2.1 Gallon	With Plate	----
PCM5314U	6 42367 44018 3	5"	3'	1-1/4"	4.5 Gallon	With Plate	----
PCM5318U	6 42367 44019 0	5"	3'	1-1/4"	6 Gallon	With Plate	----
PCM5320U	6 42367 44020 6	5"	3'	2"	No Tank	With Plate	----
PCM5328U	6 42367 44021 3	5"	3'	2"	6 Gallon	With Plate	----
PCM5402U	6 42367 44022 0	5"	4'	1"	2.1 Gallon	With Plate	----
PCM5410U	6 42367 43882 1	5"	4'	1-1/4"	No Tank	With Plate	237.0
PCM5412U	6 42367 43742 8	5"	4'	1-1/4"	2.1 Gallon	With Plate	229.0
PCM5414U	6 42367 43743 5	5"	4'	1-1/4"	4.5 Gallon	With Plate	229.0
PCM5418U	6 42367 43744 2	5"	4'	1-1/4"	6 Gallon	With Plate	233.0
PCM5420U	6 42367 43903 3	5"	4'	2"	No Tank	With Plate	231.0
PCM5428U	6 42367 43745 9	5"	4'	2"	6 Gallon	With Plate	244.0
PCM5502U	6 42367 44023 7	5"	5'	1"	2.1 Gallon	With Plate	----
PCM5510U	6 42367 43883 8	5"	5'	1-1/4"	No Tank	With Plate	255.5
PCM5512U	6 42367 43746 6	5"	5'	1-1/4"	2.1 Gallon	With Plate	----
PCM5514U	6 42367 43747 3	5"	5'	1-1/4"	4.5 Gallon	With Plate	264.0
PCM5518U	6 42367 43748 0	5"	5'	1-1/4"	6 Gallon	With Plate	269.0
PCM5520U	6 42367 43884 5	5"	5'	2"	No Tank	With Plate	267.0
PCM5528U	6 42367 43749 7	5"	5'	2"	6 Gallon	With Plate	280.0
PCM5602U	6 42367 44024 4	5"	6'	1"	2.1 Gallon	With Plate	----
PCM5610U	6 42367 44025 1	5"	6'	1-1/4"	No Tank	With Plate	280.0
PCM5612U	6 42367 43750 3	5"	6'	1-1/4"	2.1 Gallon	With Plate	280.0
PCM5614U	6 42367 43751 0	5"	6'	1-1/4"	4.5 Gallon	With Plate	264.0
PCM5618U	6 42367 43752 7	5"	6'	1-1/4"	6 Gallon	With Plate	----
PCM5620U	6 42367 44026 8	5"	6'	2"	No Tank	With Plate	----
PCM5628U	6 42367 43753 4	5"	6'	2"	6 Gallon	With Plate	----
PCM5702U	6 42367 44027 5	5"	7'	1"	2.1 Gallon	With Plate	----
PCM5710U	6 42367 44028 2	5"	7'	1-1/4"	No Tank	With Plate	----
PCM5712U	6 42367 44029 9	5"	7'	1-1/4"	2.1 Gallon	With Plate	----
PCM5714U	6 42367 44030 5	5"	7'	1-1/4"	4.5 Gallon	With Plate	----
PCM5718U	6 42367 44031 2	5"	7'	1-1/4"	6 Gallon	With Plate	----
PCM5720U	6 42367 44032 9	5"	7'	2"	No Tank	With Plate	----
PCM5728U	6 42367 44033 6	5"	7'	2"	6 Gallon	With Plate	----

NOTE: Units come standard with an Aluminum Well Cap
- May order without an Aluminum Well Cap - Call for Price

Extras for Easier & Better Installation (see Parts List)

APC Pitless Connectors (Ductile Iron) - APC4, APC5, APC6

APCGI Pitless Connectors (Gray Iron) - APC6GI

Anti-Seize/Gasket Lube - PAL100



Galvanized Steel Bottom Casing Threads



WARNING: This product can expose you to lead, which is known to the State of California to cause cancer, birth defects or other reproductive harm. For more information go to www.P65Warnings.ca.gov



WARNING: This product meets Federal USA Drinking Water requirements but has not been specifically tested or approved as no-lead in the State of California.



ANSI Standard 1585-2010 (2015) (2020)
NSF International 61 (2011) (2015)

U.S. Patent #
6,592,342



No-Lead

12" Galvanized Steel Upper Casing to 6" Well Casing

Order Number	UPC Bar Code (Qty.1)	Casing Size	Bury Depth	Discharge Size	Tank Size	Watertight Cap Included	Approx. Weight
6" Casing Models							
PCM6302U	6 42367 43972 9	6"	3'	1"	2.1 Gallon	With Plate	----
PCM6310U	6 42367 43973 6	6"	3'	1-1/4"	No Tank	With Plate	----
PCM6312U	6 42367 43974 3	6"	3'	1-1/4"	2.1 Gallon	With Plate	----
PCM6314U	6 42367 43975 0	6"	3'	1-1/4"	4.5 Gallon	With Plate	----
PCM6318U	6 42367 43976 7	6"	3'	1-1/4"	6 Gallon	With Plate	----
PCM6320U	6 42367 43977 4	6"	3'	2"	No Tank	With Plate	----
PCM6328U	6 42367 43978 1	6"	3'	2"	6 Gallon	With Plate	----
PCM6402U	6 42367 43979 8	6"	4'	1"	2.1 Gallon	With Plate	----
PCM6410U	6 42367 43980 4	6"	4'	1-1/4"	No Tank	With Plate	----
PCM6412U	6 42367 43754 1	6"	4'	1-1/4"	2.1 Gallon	With Plate	----
PCM6414U	6 42367 43755 8	6"	4'	1-1/4"	4.5 Gallon	With Plate	260.0
PCM6418U	6 42367 43756 5	6"	4'	1-1/4"	6 Gallon	With Plate	----
PCM6420U	6 42367 43981 1	6"	4'	2"	No Tank	With Plate	----
PCM6428U	6 42367 43757 2	6"	4'	2"	6 Gallon	With Plate	----
PCM6502U	6 42367 43982 8	6"	5'	1"	2.1 Gallon	With Plate	----
PCM6510U	6 42367 43983 5	6"	5'	1-1/4"	No Tank	With Plate	----
PCM6512U	6 42367 43758 9	6"	5'	1-1/4"	2.1 Gallon	With Plate	----
PCM6514U	6 42367 43759 6	6"	5'	1-1/4"	4.5 Gallon	With Plate	260.0
PCM6518U	6 42367 43760 2	6"	5'	1-1/4"	6 Gallon	With Plate	276.9
PCM6520U	6 42367 43900 2	6"	5'	2"	No Tank	With Plate	255.5
PCM6528U	6 42367 43761 9	6"	5'	2"	6 Gallon	With Plate	281.0
PCM6602U	6 42367 43984 2	6"	6'	1"	2.1 Gallon	With Plate	----
PCM6610U	6 42367 43985 9	6"	6'	1-1/4"	No Tank	With Plate	----
PCM6612U	6 42367 43762 6	6"	6'	1-1/4"	2.1 Gallon	With Plate	290.0
PCM6614U	6 42367 43763 3	6"	6'	1-1/4"	4.5 Gallon	With Plate	290.0
PCM6618U	6 42367 43764 0	6"	6'	1-1/4"	6 Gallon	With Plate	----
PCM6620U	6 42367 43986 6	6"	6'	2"	No Tank	With Plate	306.0
PCM6628U	6 42367 43765 7	6"	6'	2"	6 Gallon	With Plate	306.0
PCM6702U	6 42367 43987 3	6"	7'	1"	2.1 Gallon	With Plate	----
PCM6710U	6 42367 43988 0	6"	7'	1-1/4"	No Tank	With Plate	254.5
PCM6712U	6 42367 43989 7	6"	7'	1-1/4"	2.1 Gallon	With Plate	----
PCM6714U	6 42367 43990 3	6"	7'	1-1/4"	4.5 Gallon	With Plate	----
PCM6718U	6 42367 43991 0	6"	7'	1-1/4"	6 Gallon	With Plate	----
PCM6720U	6 42367 43992 7	6"	7'	2"	No Tank	With Plate	----
PCM6728U	6 42367 43993 4	6"	7'	2"	6 Gallon	With Plate	----

NOTE: Units come standard with an Aluminum Well Cap
- May order without an Aluminum Well Cap - Call for Price

Extras for Easier & Better Installation (see Parts List)

APC Pitless Connectors (Ductile Iron) - APC4, APC5, APC6

APCGI Pitless Connectors (Gray Iron) - APC6GI

Anti-Seize/Gasket Lube - PAL100



Galvanized Steel Bottom Casing Threads



WARNING: This product can expose you to lead, which is known to the State of California to cause cancer, birth defects or other reproductive harm. For more information go to www.P65Warnings.ca.gov



WARNING: This product meets Federal USA Drinking Water requirements but has not been specifically tested or approved as no-lead in the State of California.



H2O PITLESS CONTROL

U.S. Patent #
6,592,342



No-Lead

12" Galvanized Steel Upper Casing to 8" Well Casing

Order Number	UPC Bar Code (Qty.1)	Casing Size	Bury Depth	Discharge Size	Tank Size	Watertight Cap Included	Approx. Weight
8" Casing Models							
PCM8312U	6 42367 43994 1	8"	3'	1-1/4"	2.1 Gallon	With Plate	----
PCM8314U	6 42367 43995 8	8"	3'	1-1/4"	4.5 Gallon	With Plate	----
PCM8318U	6 42367 43996 5	8"	3'	1-1/4"	6 Gallon	With Plate	----
PCM8322U	6 42367 43997 2	8"	3'	2"	2.1 Gallon	With Plate	----
PCM8324U	6 42367 43998 9	8"	3'	2"	4.5 Gallon	With Plate	----
PCM8328U	6 42367 43999 6	8"	3'	2"	6 Gallon	With Plate	----
PCM8412U	6 42367 43766 4	8"	4'	1-1/4"	2.1 Gallon	With Plate	----
PCM8414U	6 42367 43767 1	8"	4'	1-1/4"	4.5 Gallon	With Plate	----
PCM8418U	6 42367 43768 8	8"	4'	1-1/4"	6 Gallon	With Plate	----
PCM8422U	6 42367 44000 8	8"	4'	2"	2.1 Gallon	With Plate	----
PCM8424U	6 42367 44001 5	8"	4'	2"	4.5 Gallon	With Plate	320.0
PCM8428U	6 42367 43769 5	8"	4'	2"	6 Gallon	With Plate	----
PCM8512U	6 42367 43770 1	8"	5'	1-1/4"	2.1 Gallon	With Plate	----
PCM8514U	6 42367 43771 8	8"	5'	1-1/4"	4.5 Gallon	With Plate	----
PCM8518U	6 42367 43772 5	8"	5'	1-1/4"	6 Gallon	With Plate	----
PCM8522U	6 42367 44002 2	8"	5'	2"	2.1 Gallon	With Plate	----
PCM8524U	6 42367 44003 9	8"	5'	2"	4.5 Gallon	With Plate	----
PCM8528U	6 42367 43773 2	8"	5'	2"	6 Gallon	With Plate	320.0
PCM8612U	6 42367 44004 6	8"	6'	1-1/4"	2.1 Gallon	With Plate	----
PCM8614U	6 42367 44005 3	8"	6'	1-1/4"	4.5 Gallon	With Plate	----
PCM8618U	6 42367 44006 0	8"	6'	1-1/4"	6 Gallon	With Plate	----
PCM8622U	6 42367 44007 7	8"	6'	2"	2.1 Gallon	With Plate	----
PCM8624U	6 42367 44008 4	8"	6'	2"	4.5 Gallon	With Plate	----
PCM8628U	6 42367 44009 1	8"	6'	2"	6 Gallon	With Plate	----

NOTE: Units come standard with an Aluminum Well Cap
- May order without an Aluminum Well Cap - Call for Price

Extras for Easier & Better Installation (see Parts List)

- APC Pitless Connectors (Ductile Iron) - APC4, APC5, APC6
- APCGI Pitless Connectors (Gray Iron) - APC6GI
- Anti-Seize/Gasket Lube - PAL100



Galvanized Steel Bottom Casing Threads



Galvanized Steel Casing shown featuring Stainless Steel components



WARNING: This product can expose you to lead, which is known to the State of California to cause cancer, birth defects or other reproductive harm. For more information go to www.P65Warnings.ca.gov



WARNING: This product meets Federal USA Drinking Water requirements but has not been specifically tested or approved as no-lead in the State of California.



12" PVC Upper Casing to 4" Well Casing

U.S. Patent #
7,118,357



 No-Lead

Order Number	UPC Bar Code (Qty.1)	Casing Size	Bury Depth	Discharge Size	Tank Size	Watertight Cap Included	Approx. Weight
4" Casing Models							
PPCM4302U	6 42367 43774 9	4"	3'	1"	2.1 Gallon	With Plate	90.0
PPCM4310U	6 42367 44041 1	4"	3'	1-1/4"	No Tank	With Plate	----
PPCM4312U	6 42367 43777 0	4"	3'	1-1/4"	2.1 Gallon	With Plate	----
PPCM4314U	6 42367 43778 7	4"	3'	1-1/4"	4.5 Gallon	With Plate	90.0
PPCM4318U	6 42367 43779 4	4"	3'	1-1/4"	6 Gallon	With Plate	----
PPCM4402U	6 42367 44043 5	4"	4'	1"	2.1 Gallon	With Plate	90.0
PPCM4410U	6 42367 44044 2	4"	4'	1-1/4"	No Tank	With Plate	----
PPCM4412U	6 42367 44045 9	4"	4'	1-1/4"	2.1 Gallon	With Plate	----
PPCM4414U	6 42367 44046 6	4"	4'	1-1/4"	4.5 Gallon	With Plate	90.0
PPCM4418U	6 42367 44047 3	4"	4'	1-1/4"	6 Gallon	With Plate	----
PPCM4502U	6 42367 44050 3	4"	5'	1"	2.1 Gallon	With Plate	----
PPCM4510U	6 42367 44051 0	4"	5'	1-1/4"	No Tank	With Plate	----
PPCM4512U	6 42367 44052 7	4"	5'	1-1/4"	2.1 Gallon	With Plate	----
PPCM4514U	6 42367 44053 4	4"	5'	1-1/4"	4.5 Gallon	With Plate	96.0
PPCM4518U	6 42367 44054 1	4"	5'	1-1/4"	6 Gallon	With Plate	----
PPCM4602U	6 42367 44057 2	4"	6'	1"	2.1 Gallon	With Plate	----
PPCM4610U	6 42367 44058 9	4"	6'	1-1/4"	No Tank	With Plate	----
PPCM4612U	6 42367 44059 6	4"	6'	1-1/4"	2.1 Gallon	With Plate	----
PPCM4614U	6 42367 44060 2	4"	6'	1-1/4"	4.5 Gallon	With Plate	----
PPCM4618U	6 42367 44061 9	4"	6'	1-1/4"	6 Gallon	With Plate	----
PPCM4702U	6 42367 44064 0	4"	7'	1"	2.1 Gallon	With Plate	90.0
PPCM4710U	6 42367 44065 7	4"	7'	1-1/4"	No Tank	With Plate	----
PPCM4712U	6 42367 44066 4	4"	7'	1-1/4"	2.1 Gallon	With Plate	----
PPCM4714U	6 42367 44067 1	4"	7'	1-1/4"	4.5 Gallon	With Plate	----
PPCM4718U	6 42367 44068 8	4"	7'	1-1/4"	6 Gallon	With Plate	----

NOTE: Units come standard with an Aluminum Well Cap
- May order without an Aluminum Well Cap - Call for Price



PVC Casing shown featuring Stainless Steel components



WARNING: This product can expose you to lead, which is known to the State of California to cause cancer, birth defects or other reproductive harm. For more information go to www.P65Warnings.ca.gov



WARNING: This product meets Federal USA Drinking Water requirements but has not been specifically tested or approved as no-lead in the State of California.

H2O PITLESS CONTROL

12" PVC Upper Casing to 5" Well Casing

U.S. Patent #
7,118,357



 No-Lead

Order Number	UPC Bar Code (Qty.1)	Casing Size	Bury Depth	Discharge Size	Tank Size	Watertight Cap Included	Approx. Weight
5" Casing Models							
PPCM5302U	6 42367 43781 7	5"	3'	1"	2.1 Gallon	With Plate	90.0
PPCM5310U	6 42367 44071 8	5"	3'	1-1/4"	No Tank	With Plate	90.0
PPCM5312U	6 42367 43784 8	5"	3'	1-1/4"	2.1 Gallon	With Plate	----
PPCM5314U	6 42367 43785 5	5"	3'	1-1/4"	4.5 Gallon	With Plate	----
PPCM5318U	6 42367 43786 2	5"	3'	1-1/4"	6 Gallon	With Plate	90.0
PPCM5320U	6 42367 44072 5	5"	3'	2"	No Tank	With Plate	90.0
PPCM5328U	6 42367 43787 9	5"	3'	2"	6 Gallon	With Plate	----
PPCM5402U	6 42367 44073 2	5"	4'	1"	2.1 Gallon	With Plate	229.0
PPCM5410U	6 42367 44074 9	5"	4'	1-1/4"	No Tank	With Plate	90.0
PPCM5412U	6 42367 44075 6	5"	4'	1-1/4"	2.1 Gallon	With Plate	90.0
PPCM5414U	6 42367 44076 3	5"	4'	1-1/4"	4.5 Gallon	With Plate	90.0
PPCM5418U	6 42367 44077 0	5"	4'	1-1/4"	6 Gallon	With Plate	----
PPCM5420U	6 42367 44078 7	5"	4'	2"	No Tank	With Plate	----
PPCM5428U	6 42367 44079 4	5"	4'	2"	6 Gallon	With Plate	90.0
PPCM5502U	6 42367 44080 0	5"	5'	1"	2.1 Gallon	With Plate	90.0
PPCM5510U	6 42367 44081 7	5"	5'	1-1/4"	No Tank	With Plate	90.0
PPCM5512U	6 42367 44082 4	5"	5'	1-1/4"	2.1 Gallon	With Plate	95.8
PPCM5514U	6 42367 44083 1	5"	5'	1-1/4"	4.5 Gallon	With Plate	90.0
PPCM5518U	6 42367 44085 5	5"	5'	1-1/4"	6 Gallon	With Plate	90.0
PPCM5520U	6 42367 44086 2	5"	5'	2"	No Tank	With Plate	90.0
PPCM5528U	6 42367 44087 9	5"	5'	2"	6 Gallon	With Plate	90.0
PPCM5602U	6 42367 44088 6	5"	6'	1"	2.1 Gallon	With Plate	----
PPCM5610U	6 42367 44089 3	5"	6'	1-1/4"	No Tank	With Plate	96.6
PPCM5612U	6 42367 44090 9	5"	6'	1-1/4"	2.1 Gallon	With Plate	----
PPCM5614U	6 42367 44091 6	5"	6'	1-1/4"	4.5 Gallon	With Plate	----
PPCM5618U	6 42367 44092 3	5"	6'	1-1/4"	6 Gallon	With Plate	----
PPCM5620U	6 42367 44093 0	5"	6'	2"	No Tank	With Plate	----
PPCM5628U	6 42367 44094 7	5"	6'	2"	6 Gallon	With Plate	121.2
PPCM5702U	6 42367 44095 4	5"	7'	1"	2.1 Gallon	With Plate	169.1
PPCM5710U	6 42367 44096 1	5"	7'	1-1/4"	No Tank	With Plate	----
PPCM5712U	6 42367 44097 8	5"	7'	1-1/4"	2.1 Gallon	With Plate	----
PPCM5714U	6 42367 44098 5	5"	7'	1-1/4"	4.5 Gallon	With Plate	----
PPCM5718U	6 42367 44100 5	5"	7'	1-1/4"	6 Gallon	With Plate	175.7
PPCM5720U	6 42367 44101 2	5"	7'	2"	No Tank	With Plate	----
PPCM5728U	6 42367 44102 9	5"	7'	2"	6 Gallon	With Plate	----

NOTE: Units come standard with an Aluminum Well Cap
- May order without an Aluminum Well Cap - Call for Price



WARNING: This product can expose you to lead, which is known to the State of California to cause cancer, birth defects or other reproductive harm. For more information go to www.P65Warnings.ca.gov



WARNING: This product meets Federal USA Drinking Water requirements but has not been specifically tested or approved as no-lead in the State of California.



ANSI Standard #190-2010 (R2021)
NSF International #1011 (R2021)

U.S. Patent #
7,118,357



No-Lead

12" PVC Upper Casing to 6" Well Casing

Order Number	UPC Bar Code (Qty.1)	Casing Size	Bury Depth	Discharge Size	Tank Size	Watertight Cap Included	Approx. Weight
6" Casing Models							
PPCM6302U	6 42367 43788 6	6"	3'	1"	2.1 Gallon	With Plate	90.0
PPCM6310U	6 42367 44103 6	6"	3'	1-1/4"	No Tank	With Plate	71.5
PPCM6312U	6 42367 43791 6	6"	3'	1-1/4"	2.1 Gallon	With Plate	----
PPCM6314U	6 42367 43792 3	6"	3'	1-1/4"	4.5 Gallon	With Plate	----
PPCM6318U	6 42367 43793 0	6"	3'	1-1/4"	6 Gallon	With Plate	90.0
PPCM6320U	6 42367 44104 3	6"	3'	2"	No Tank	With Plate	90.0
PPCM6328U	6 42367 43794 7	6"	3'	2"	6 Gallon	With Plate	----
PPCM6402U	6 42367 44105 0	6"	4'	1"	2.1 Gallon	With Plate	90.0
PPCM6410U	6 42367 44106 7	6"	4'	1-1/4"	No Tank	With Plate	----
PPCM6412U	6 42367 44107 4	6"	4'	1-1/4"	2.1 Gallon	With Plate	90.0
PPCM6414U	6 42367 44108 1	6"	4'	1-1/4"	4.5 Gallon	With Plate	----
PPCM6418U	6 42367 44109 8	6"	4'	1-1/4"	6 Gallon	With Plate	----
PPCM6420U	6 42367 44110 4	6"	4'	2"	No Tank	With Plate	----
PPCM6428U	6 42367 44111 1	6"	4'	2"	6 Gallon	With Plate	----
PPCM6502U	6 42367 44112 8	6"	5'	1"	2.1 Gallon	With Plate	----
PPCM6510U	6 42367 44113 5	6"	5'	1-1/4"	No Tank	With Plate	----
PPCM6512U	6 42367 44114 2	6"	5'	1-1/4"	2.1 Gallon	With Plate	----
PPCM6514U	6 42367 44115 9	6"	5'	1-1/4"	4.5 Gallon	With Plate	----
PPCM6518U	6 42367 44116 6	6"	5'	1-1/4"	6 Gallon	With Plate	----
PPCM6520U	6 42367 44117 3	6"	5'	2"	No Tank	With Plate	----
PPCM6528U	6 42367 44118 0	6"	5'	2"	6 Gallon	With Plate	114.0
PPCM6602U	6 42367 44119 7	6"	6'	1"	2.1 Gallon	With Plate	----
PPCM6610U	6 42367 44120 3	6"	6'	1-1/4"	No Tank	With Plate	90.0
PPCM6612U	6 42367 44121 0	6"	6'	1-1/4"	2.1 Gallon	With Plate	104.9
PPCM6614U	6 42367 44122 7	6"	6'	1-1/4"	4.5 Gallon	With Plate	----
PPCM6618U	6 42367 44123 4	6"	6'	1-1/4"	6 Gallon	With Plate	----
PPCM6620U	6 42367 44124 1	6"	6'	2"	No Tank	With Plate	107.8
PPCM6628U	6 42367 44125 8	6"	6'	2"	6 Gallon	With Plate	90.0
PPCM6702U	6 42367 44126 5	6"	7'	1"	2.1 Gallon	With Plate	----
PPCM6710U	6 42367 44127 2	6"	7'	1-1/4"	No Tank	With Plate	----
PPCM6712U	6 42367 44128 9	6"	7'	1-1/4"	2.1 Gallon	With Plate	----
PPCM6714U	6 42367 44129 6	6"	7'	1-1/4"	4.5 Gallon	With Plate	----
PPCM6718U	6 42367 44130 2	6"	7'	1-1/4"	6 Gallon	With Plate	----
PPCM6720U	6 42367 44131 9	6"	7'	2"	No Tank	With Plate	----
PPCM6728U	6 42367 44132 6	6"	7'	2"	6 Gallon	With Plate	----

NOTE: Units come standard with an Aluminum Well Cap
- May order without an Aluminum Well Cap - Call for Price

WARNING: This product can expose you to lead, which is known to the State of California to cause cancer, birth defects or other reproductive harm. For more information go to www.P65Warnings.ca.gov

WARNING: This product meets Federal USA Drinking Water requirements but has not been specifically tested or approved as no-lead in the State of California.



H2O PITLESS CONTROL

U.S. Patent #
7,118,357



No-Lead

12" PVC Upper Casing to 8" Well Casing

Order Number	UPC Bar Code (Qty.1)	Casing Size	Bury Depth	Discharge Size	Tank Size	Watertight Cap Included	Approx. Weight
8" Casing Models							
PPCM8312U	6 42367 43806 7	8"	3'	1-1/4"	2.1 Gallon	With Plate	90.0
PPCM8314U	6 42367 43807 4	8"	3'	1-1/4"	4.5 Gallon	With Plate	----
PPCM8318U	6 42367 43808 1	8"	3'	1-1/4"	6 Gallon	With Plate	----
PPCM8322U	6 42367 44133 3	8"	3'	2"	2.1 Gallon	With Plate	----
PPCM8324U	6 42367 44134 0	8"	3'	2"	4.5 Gallon	With Plate	90.0
PPCM8328U	6 42367 43809 8	8"	3'	2"	6 Gallon	With Plate	90.0
PPCM8412U	6 42367 44135 7	8"	4'	1-1/4"	2.1 Gallon	With Plate	----
PPCM8414U	6 42367 44136 4	8"	4'	1-1/4"	4.5 Gallon	With Plate	----
PPCM8418U	6 42367 44137 1	8"	4'	1-1/4"	6 Gallon	With Plate	----
PPCM8422U	6 42367 44138 5	8"	4'	2"	2.1 Gallon	With Plate	----
PPCM8424U	6 42367 44139 5	8"	4'	2"	4.5 Gallon	With Plate	----
PPCM8428U	6 42367 44140 1	8"	4'	2"	6 Gallon	With Plate	----
PPCM8512U	6 42367 44141 8	8"	5'	1-1/4"	2.1 Gallon	With Plate	----
PPCM8514U	6 42367 44142 5	8"	5'	1-1/4"	4.5 Gallon	With Plate	----
PPCM8518U	6 42367 44143 2	8"	5'	1-1/4"	6 Gallon	With Plate	----
PPCM8522U	6 42367 44144 9	8"	5'	2"	2.1 Gallon	With Plate	----
PPCM8524U	6 42367 44145 6	8"	5'	2"	4.5 Gallon	With Plate	----
PPCM8528U	6 42367 44146 3	8"	5'	2"	6 Gallon	With Plate	----
PPCM8612U	6 42367 44147 0	8"	6'	1-1/4"	2.1 Gallon	With Plate	----
PPCM8614U	6 42367 44148 7	8"	6'	1-1/4"	4.5 Gallon	With Plate	----
PPCM8618U	6 42367 44149 4	8"	6'	1-1/4"	6 Gallon	With Plate	----
PPCM8622U	6 42367 44150 0	8"	6'	2"	2.1 Gallon	With Plate	----
PPCM8624U	6 42367 44151 7	8"	6'	2"	4.5 Gallon	With Plate	----
PPCM8628U	6 42367 44152 4	8"	6'	2"	6 Gallon	With Plate	----

NOTE: Units come standard with an Aluminum Well Cap
- May order without an Aluminum Well Cap - Call for Price



PVC Casing
shown featuring
Stainless Steel components



WARNING: This product can expose you to lead, which is known to the State of California to cause cancer, birth defects or other reproductive harm. For more information go to www.P65Warnings.ca.gov



WARNING: This product meets Federal USA Drinking Water requirements but has not been specifically tested or approved as no-lead in the State of California.

H2O PITLESS CONTROL CENTERS

12" PVC Upper Casing - Open Bottom Installed Outside Wall



No-Lead

Order Number	UPC Bar Code (Qty.1)	Bury Depth	Discharge Size	Tank Size	Watertight Cap Included	Approx. Weight
PPCC12302U	6 42367 44167 8	3'	1"	2.1 Gallon	With Plate	----
PPCC12310U	6 42367 44168 5	3'	1-1/4"	No Tank	With Plate	----
PPCC12312U	6 42367 44169 2	3'	1-1/4"	2.1 Gallon	With Plate	----
PPCC12314U	6 42367 44170 8	3'	1-1/4"	4.5 Gallon	With Plate	----
PPCC12318U	6 42367 44171 5	3'	1-1/4"	6 Gallon	With Plate	----
PPCC12320U	6 42367 44172 2	3'	2"	No Tank	With Plate	----
PPCC12328U	6 42367 44173 9	3'	2"	6 Gallon	With Plate	----
PPCC12402U	6 42367 44174 6	4'	1"	2.1 Gallon	With Plate	----
PPCC12410U	6 42367 44175 3	4'	1-1/4"	No Tank	With Plate	----
PPCC12412U	6 42367 44176 0	4'	1-1/4"	2.1 Gallon	With Plate	----
PPCC12414U	6 42367 44177 7	4'	1-1/4"	4.5 Gallon	With Plate	----
PPCC12418U	6 42367 44178 4	4'	1-1/4"	6 Gallon	With Plate	----
PPCC12420U	6 42367 44179 7	4'	2"	No Tank	With Plate	----
PPCC12428U	6 42367 44180 7	4'	2"	6 Gallon	With Plate	----
PPCC12502U	6 42367 44181 4	5'	1"	2.1 Gallon	With Plate	----
PPCC12510U	6 42367 44182 1	5'	1-1/4"	No Tank	With Plate	----
PPCC12512U	6 42367 44183 8	5'	1-1/4"	2.1 Gallon	With Plate	----
PPCC12514U	6 42367 44184 5	5'	1-1/4"	4.5 Gallon	With Plate	----
PPCC12518U	6 42367 44185 2	5'	1-1/4"	6 Gallon	With Plate	----
PPCC12520U	6 42367 44186 9	5'	2"	No Tank	With Plate	----
PPCC12528U	6 42367 44187 6	5'	2"	6 Gallon	With Plate	----
PPCC12602U	6 42367 44188 3	6'	1"	2.1 Gallon	With Plate	----
PPCC12610U	6 42367 44189 0	6'	1-1/4"	No Tank	With Plate	----
PPCC12612U	6 42367 44190 6	6'	1-1/4"	2.1 Gallon	With Plate	----
PPCC12614U	6 42367 44191 3	6'	1-1/4"	4.5 Gallon	With Plate	----
PPCC12618U	6 42367 44192 0	6'	1-1/4"	6 Gallon	With Plate	----
PPCC12620U	6 42367 44193 7	6'	2"	No Tank	With Plate	----
PPCC12628U	6 42367 44194 4	6'	2"	6 Gallon	With Plate	----
PPCC12702U	6 42367 44195 1	7'	1"	2.1 Gallon	With Plate	----
PPCC12710U	6 42367 44196 8	7'	1-1/4"	No Tank	With Plate	----
PPCC12712U	6 42367 44197 5	7'	1-1/4"	2.1 Gallon	With Plate	----
PPCC12714U	6 42367 44198 2	7'	1-1/4"	4.5 Gallon	With Plate	----
PPCC12718U	6 42367 44199 9	7'	1-1/4"	6 Gallon	With Plate	----
PPCC12720U	6 42367 44200 2	7'	2"	No Tank	With Plate	----
PPCC12728U	6 42367 44201 9	7'	2"	6 Gallon	With Plate	----



12" Aluminum Well Cap with Mounting Plate



Examples of Drive Pump Controls that may be mounted to plate

H2O PITLESS UNIT COMPONENTS

AT THE WELL PRESSURE SWITCH CONTROL

INCLUDED IN KIT:

- Pressure Switch Bracket - Bolts to Pull Coupling
- All Fittings Needed to Connect Pressure Switch
- Tubing and Clamps to Connect Pressure Switch
- Cycle Stop Valve - Directly Below Pitless Adapter

(Not included in kit - can use any pressure switch or heavy-duty MPSXHD or MCSHD control switch)



Cycle Stop Valve Directly Below Pitless Adapter

Pressure Switch Bracket

FEATURES AND BENEFITS

- A** Bracket for Mounting Pressure Switch
- B** Provides easy installation of pressure switch inside the H2O Unit
- C** The pressure switch is below the tank and is still easily removed with tank when needed
- D** Expansion tank, fittings, piping connections, and cycle stop valve included and pressure switch to complete installation of pump control and provides serviceability
- E** Easiest low cost answer
- F** Everything fits inside 12" casing

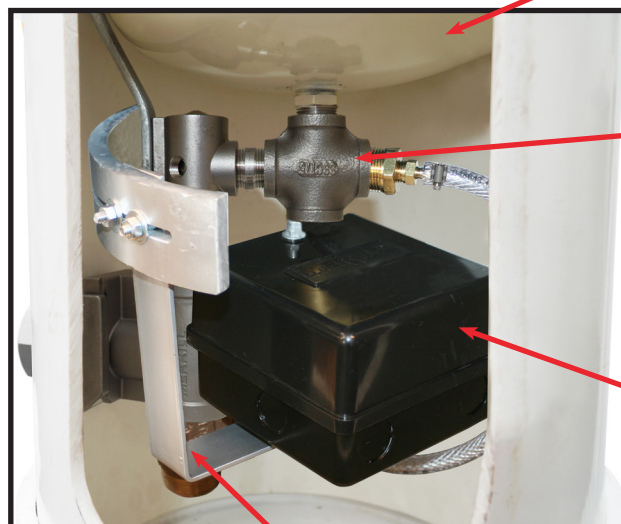

Pressure Tank

Stainless Steel Cross

Merrill Pressure Switch or Control Switch

H2O Bracket with Pressure Switch or Control Switch installed

H2O PITLESS UNIT COMPONENTS FOR AT THE WELL PRESSURE SWITCH CONTROL

H2O At the Well Pressure Switch Control Parts List



No-Lead

Order Number	UPC Bar Code (Qty.1)	Description
H2PSB	6 42367 45349 7	Pressure Switch Bracket
H2PSFS	6 42367 45350 3	Fittings to Connect Pressure Switch
H2TAC	6 42367 45351 0	Tubing and Clamps to Connect Fittings
H2CSV	6 42367 45352 7	Cycle Stop Valve Install Below Pitless Adapter
1/4"IDTUBE	6 42367 45445 6	1/4" Inside Diameter Braided Vinyl Tubing
RBNLHB7525	6 42367 45446 3	3/4" x 1/4" No Lead Red Brass Hex Bushing
MPSXHD	----	Merrill MPSXHD Pressure Switch (not included)
MCSHD	----	Merrill MCSHD Control Switch (not included)



H2PSFS



H2TAC



Merrill MPSXHD Pressure Switch



H2PSB

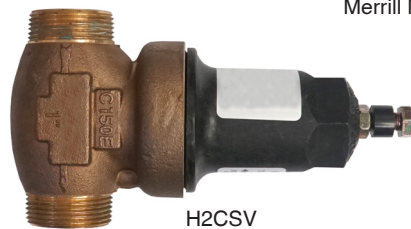

H2CSV



Merrill MCSHD Control Switch

Merrill H2O Pressure Switch Control Package Includes:

Order No. H2OPSCP UPC Bar Code 6 42367 45453 1

- No-Lead Brass Bushing (Part No. H2PSFS)
- No-Lead Brass Fittings (Part No. H2PSFS)
- Reinforced Tubing and Stainless Steel Clamps (Part No. H2TAC)
- Pressure Switch Bracket (Part No. H2PSB)
- Cycle Stop Valve (Part No. H2CSV)

NOTE: This Package is to be used with a 6 gallon tank or larger

The H2O Pressure Switch Control is recommended to be used with Merrill MPSXHD Pressure Switch or Merrill MCSHD Control Switch that eliminates the control box.

MPSXHD Switches - Are rated up to 5HP

MCSHD Control Switches - Are rated up to 5HP

H2O PITLESS CONTROL

PARTS AND ACCESSORIES

H2O Parts List



No-Lead

Order Number	UPC Bar Code (Qty.1)	Description
H2BVF12SS	6 42367 45494 4	Stainless Steel Female Valve
H2BVM125SS	6 42367 45495 1	1-1/4" Pull Pipe Stainless Steel Male Valve
OR210	6 42367 43853 1	#210 O-Ring
STRAP27	6 42367 43832 6	1/4" x 1" x 27" Pull Strap
STRAP41	6 42367 43833 3	1/4" x 1" x 41" Pull Strap
STRAP53	6 42367 43834 0	1/4" x 1" x 53" Pull Strap
STRAP65	6 42367 43835 7	1/4" x 1" x 65" Pull Strap
STRAP77	6 42367 43836 4	1/4" x 1" x 77" Pull Strap
WCH12T	6 42367 43888 3	12" Aluminum Well Cap Cover
WCH12B	6 42367 43889 0	12" Aluminum Bottom Ring
H2UP	6 42367 43855 5	Aluminum Universal Plate
WCH120	6 42367 43886 9	12" Well Cap and Bottom Ring Unit (Tapped for mounting plate)
WCH1200UB	6 42367 43890 6	12" Well Cap and Bottom Ring with Mounting Plate
OR457	6 42367 43816 6	12" Cover O-Ring
OR454	6 42367 43815 9	12" Bottom Ring O-Ring
SSMB125H2	6 42367 45496 8	Heavy-Duty Stainless Steel 1-1/4" Pitless Adapter
MBNL300D	6 42367 43893 7	MBNL300 2" Discharge
SSP25	6 42367 45504 0	1/4" 304 Stainless Steel Square Plug
SSN75015	6 42367 45497 5	3/4" x 1-1/2" Stainless Steel Nipple
SSCT75	6 42367 45430 2	3/4" Stainless Steel Cross
CT66536	6 42367 43837 1	36" Cable Tie
H2PT2	6 42367 43896 8	2.1 Gallon Pressure Tank
H2PT4	6 42367 43897 5	4.5 Gallon Pressure Tank
H2PT6	6 42367 45506 4	6 Gallon Pressure Tank
C5	6 42367 09463 8	Stainless Steel Pull Strap Bolt 1/4" x 1/2"
3/4SCREEN	6 42367 05121 1	Vent Screen
GG51/4	6 42367 01602 9	Green Ground Screw
SS1/4X5/8HCS	6 42367 41182 4	Stainless Steel Ring Bolt
SS1/2X1-1/2	6 42367 41989 9	Stainless Steel Lid Bolt
SS1/4HN	6 42367 43854 8	Stainless Steel 1/4-20 Hex Nut

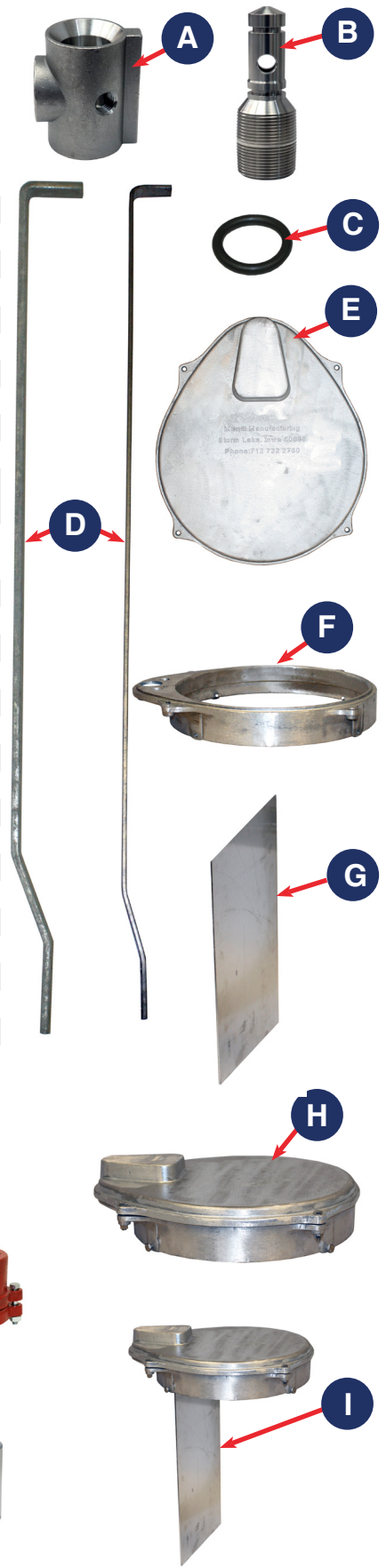

Extras for Easier and Better Installation

MERRILL APC Pitless Connectors

DUCTILE IRON Connector for threaded pitless to plain end casing with neoprene gasket

Order Number	UPC Bar Code (Qty.1)	Hex Head Casing	Bolts	Approx. Wt./Lbs.
APC4	6 42367 00759 1	4"	1/2" x 3"	11.4
APC5	6 42367 00764 5	5"	1/2" x 3-1/2"	18.9
APC6	6 42367 00767 6	6"	1/2" x 3-1/2"	26.5



MERRILL APCGI Pitless Connector

GRAY IRON Connector for threaded pitless to plain end casing with neoprene gasket

APC6GI	6 42367 41956 1	6"	1/2" x 3-1/2"	26.5
--------	-----------------	----	---------------	------

Anti-Seize/Gasket Lube

Brush top can in economical/professional size

Order Number	UPC Bar Code (Qty.1)	Container Size	Carton Qty.	Approx. Wt./Lbs.
PAL100	6 42367 71704 9	1 lb. Can	12	1.0



A Part Number: H2BVF12SS
Stainless Steel Female Valve

B Part Number: H2BVM125SS
1-1/4" Pull Pipe Stainless Steel Male Valve

C Part Number: OR210
#210 O-Ring

**D Part Number: STRAP27/
STRAP41**
1/4" x 1" x 27" Pull Strap
Also 41", 53", 65", 77" Long

E Part Number: WCH12T
12" Aluminum Well Cap Cover

F Part Number: WCH12B
12" Aluminum Bottom Ring

G Part Number: H2UP
Aluminum Universal Plate

H Part Number: WCH1200
12" Well Cap and Bottom Ring Unit

I Part Number: WCH1200UB
12" Well Cap, Bottom Ring, with
Mounting Plate

J Part Number: OR457
12" Cover O-Ring

K Part Number: OR454
12" Bottom Ring O-Ring

L Part Number: SSMB125H2
Heavy-Duty Stainless Steel 1-1/4"
Pitless Adapter

M Part Number: MBNL300D
MBNL300 2" Discharge

N Part Number: SSP25
1/4" Stainless Steel Plug with
Square Head

O Part Number: SSN75015
3/4" x 1-1/2" Stainless Steel
Nipple

P Part Number: SSCT75
3/4" Stainless Steel Cross

Q Part Number: CT66536
36" Cable Tie

R Part Number: H2PT2
2.1 Gallon Pressure Tank

S Part Number: H2PT4
4.5 Gallon Pressure Tank

T Part Number: H2PT6
6 Gallon Pressure Tank

U Part Number: C-5
Stainless Steel Pull Strap Bolt
1/4" x 1/2"

V Part Number: 3/4SCREEN
Vent Screen

W Part Number: GGS1/4
Green Ground Screw

X Part Number: SS1/4X5/8HCS
Stainless Steel Ring Bolt

Y Part Number: SS1/4X1-1/2
Stainless Steel Lid Bolt

Z Part Number: SS1/4HN
Stainless Steel 1/4-20 Hex Nut

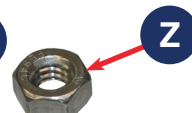
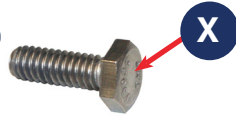
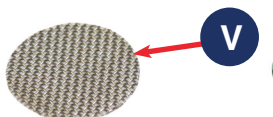
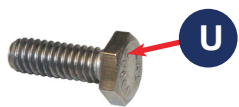
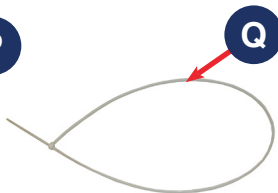
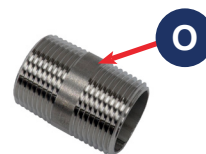
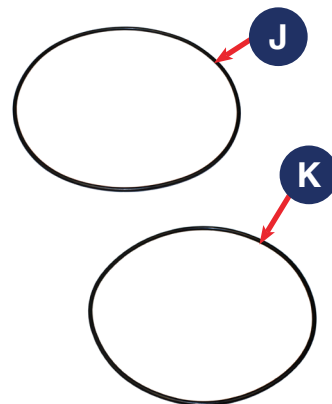



© 2026 Merrill Manufacturing Form No. 2114.16
315 Flindt Dr. | Storm Lake, Iowa 50588 | (800) 831-6962 | merrillmfg.com